

# BALSAM MILLWORK CROWNS

CR6067

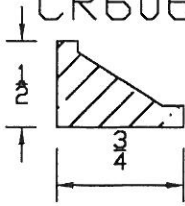

CR6001

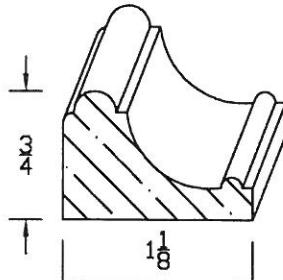

CR6031

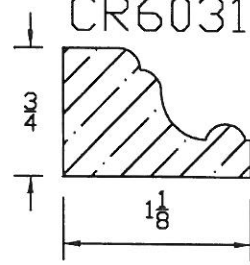

CR6038

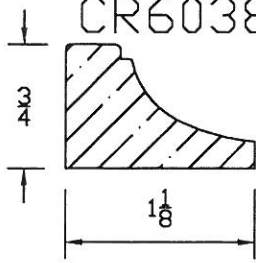

CR6049

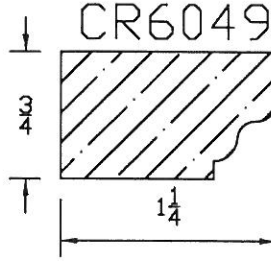

CR6039

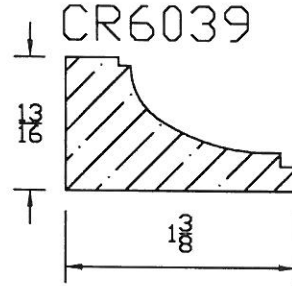

CR6102

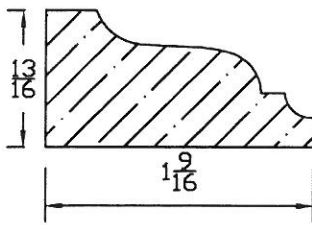

CR6030

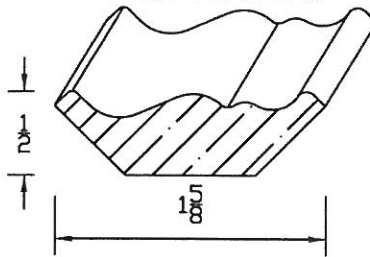

CR6034

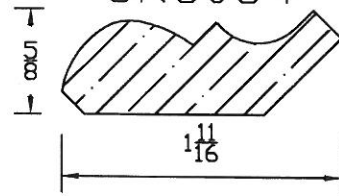

CR6036

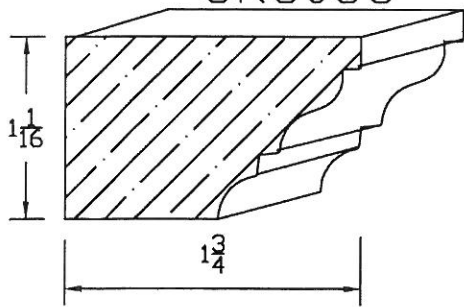

CR6109

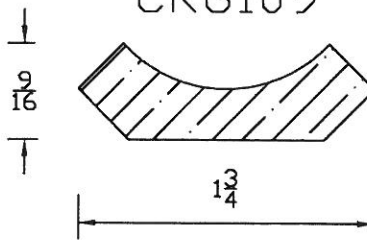

CR6085 1 13/16

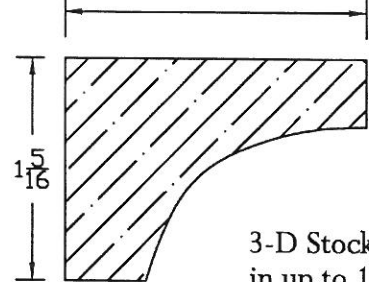

CR6058

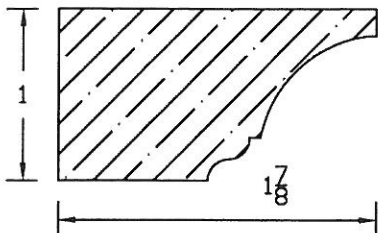

CR6045

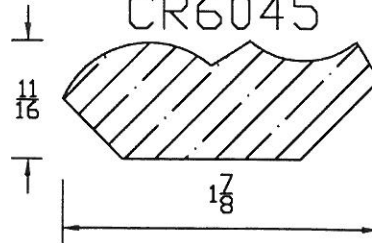

3-D Stocked  
in up to 17  
species

6001

# BALSAM MILLWORK CROWNS

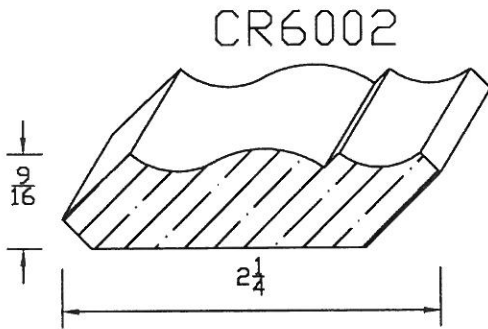
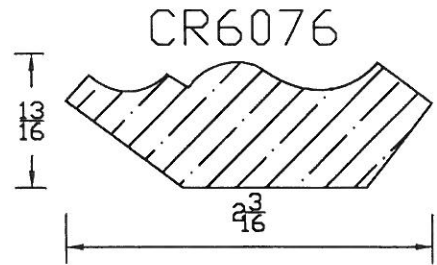
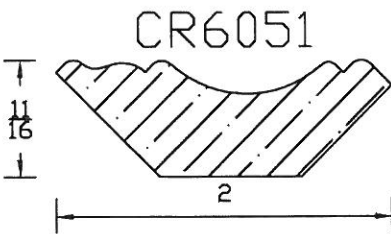
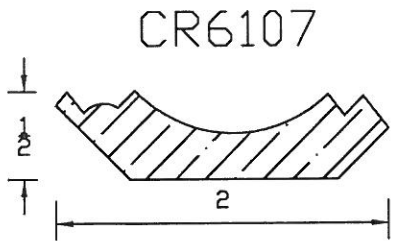
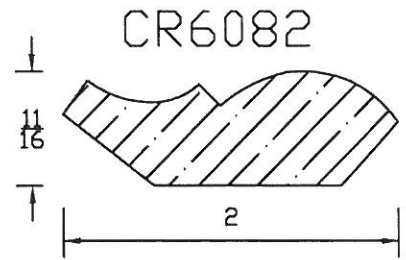
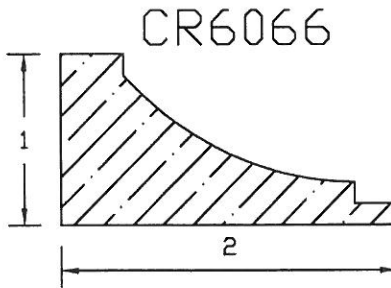
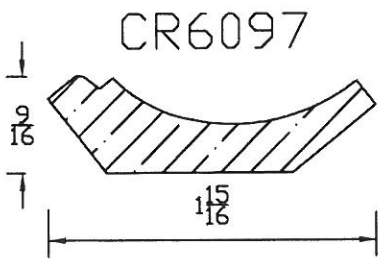

3-D Stacked in  
up to 17 species

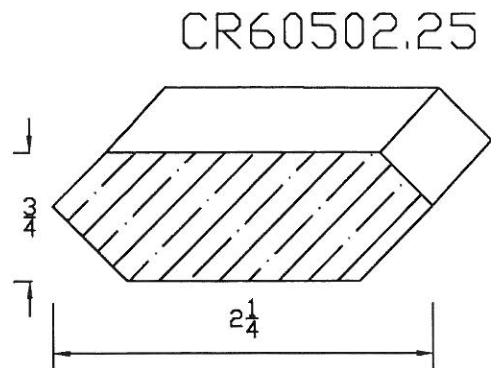
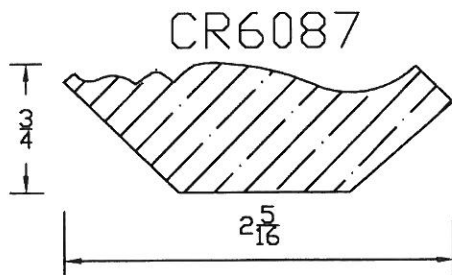
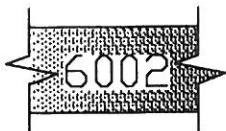
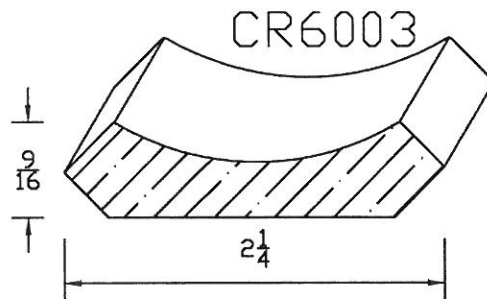
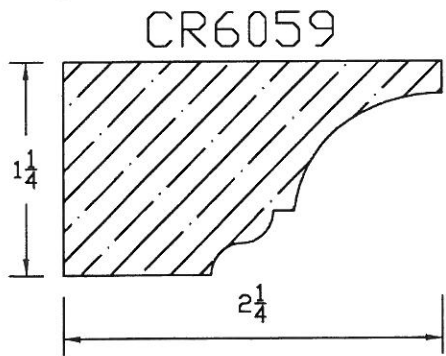
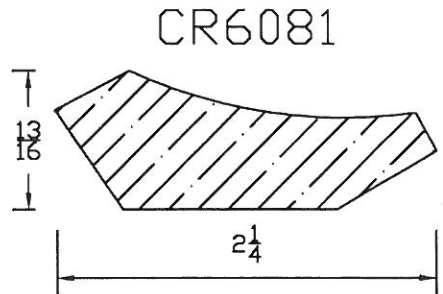

BALSAM MILLWORK CROWNS

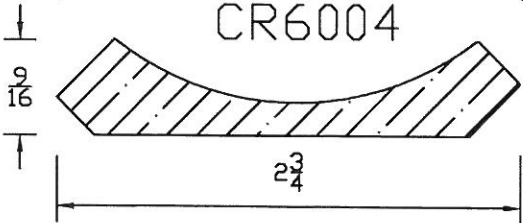
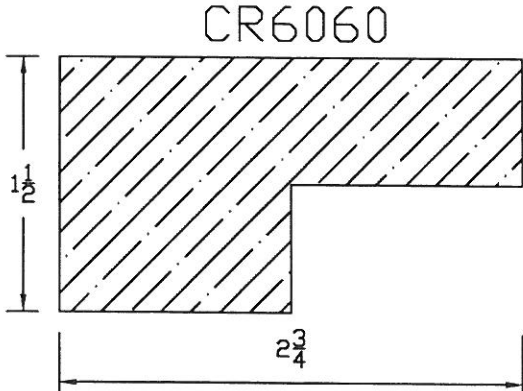
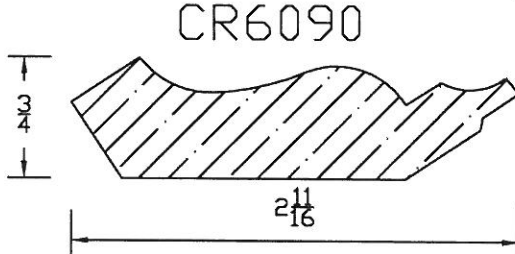
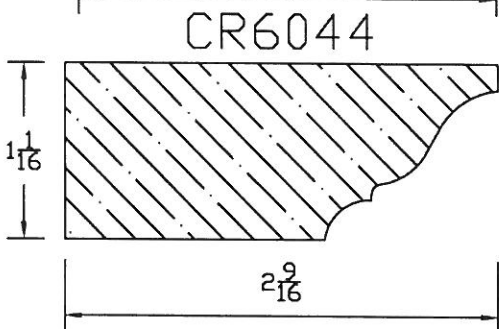
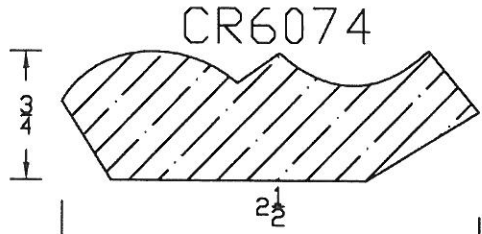
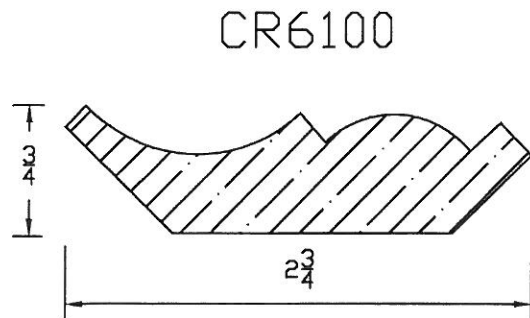
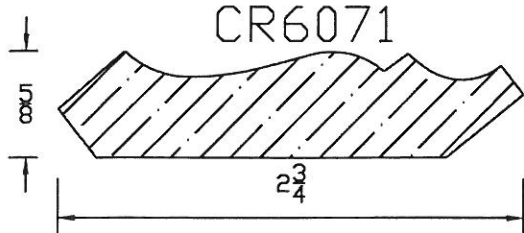
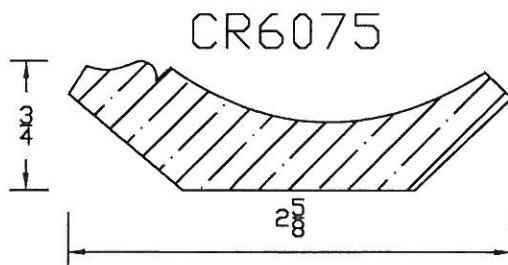
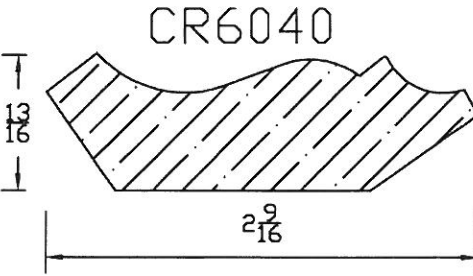
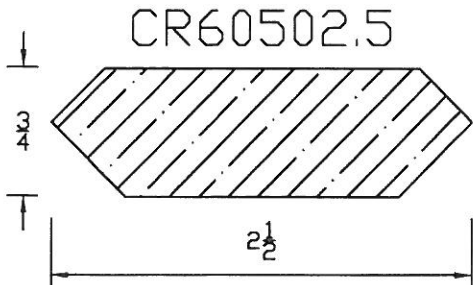

# BALSAM MILLWORK CROWNS

CR6041

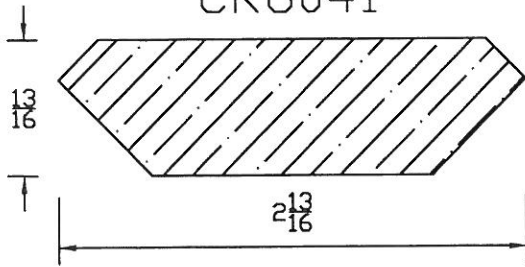

CR6032

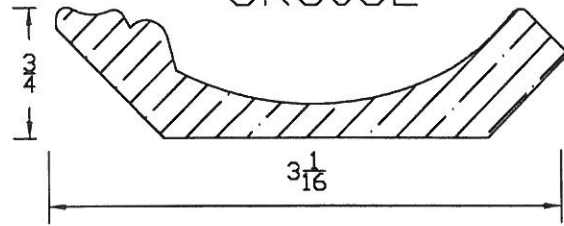

CR6061

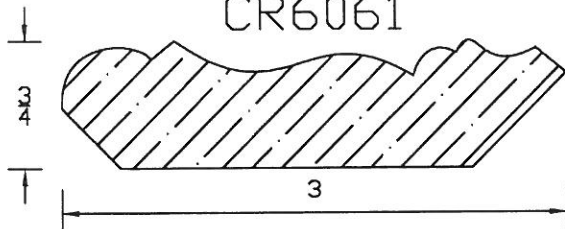

CR6033

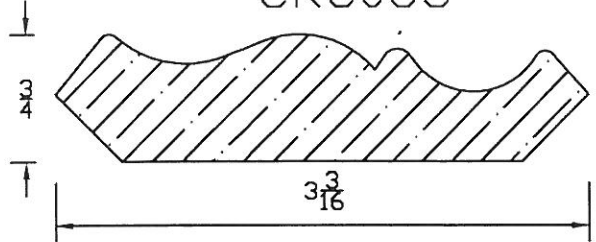

CR6005

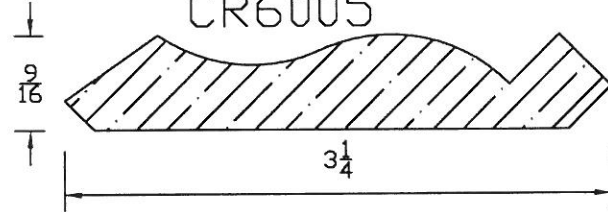

CR6048

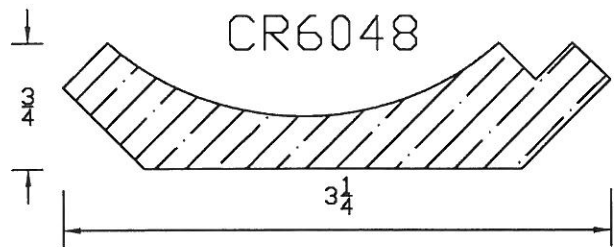

CR6006

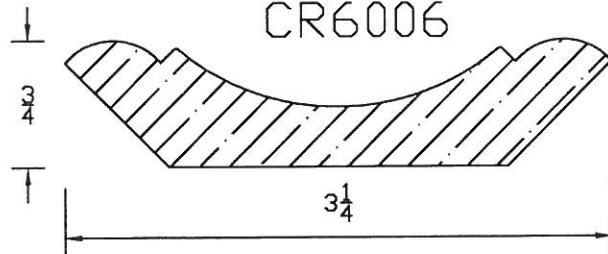

CR6007

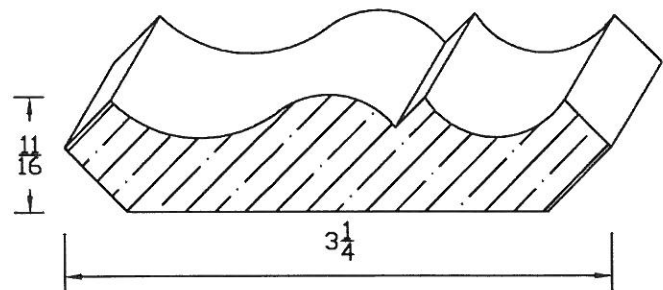

CR6052

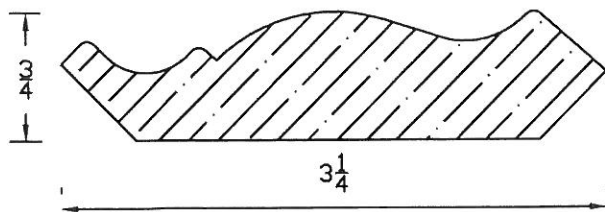

CR6077

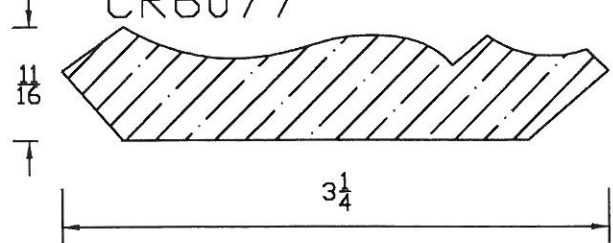

6004

3-D Stocked in up to 17 species

# BALSAM MILLWORK CROWNS

CR60503.25

3-D Stocked in up to 17 species

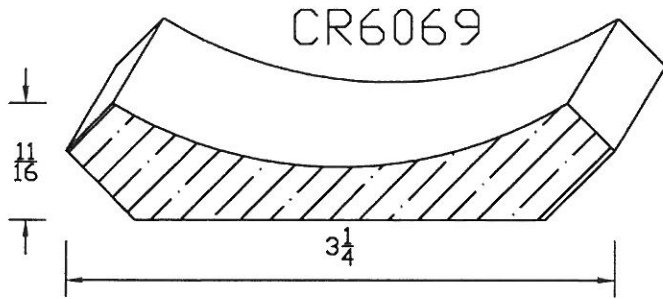
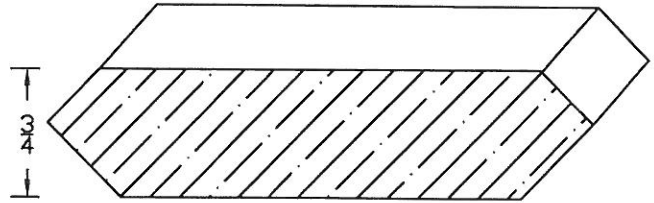

CR6096

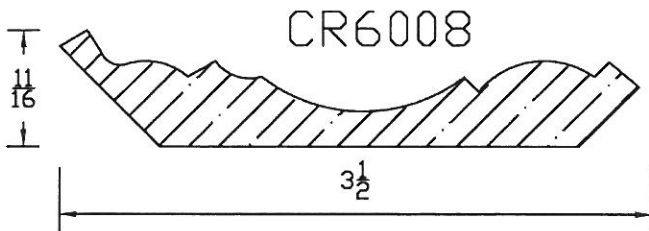
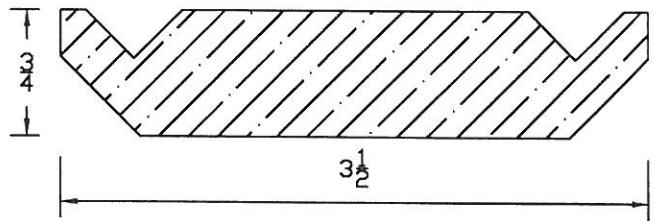

CR60503.5

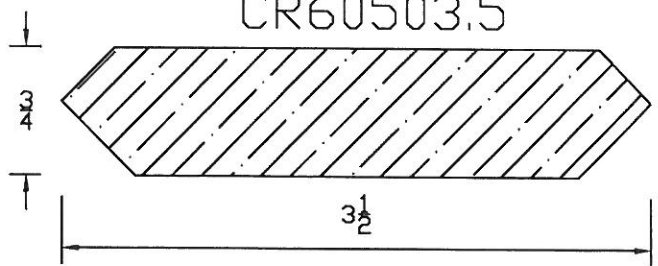

CR6101

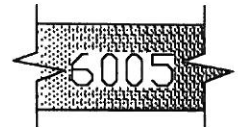
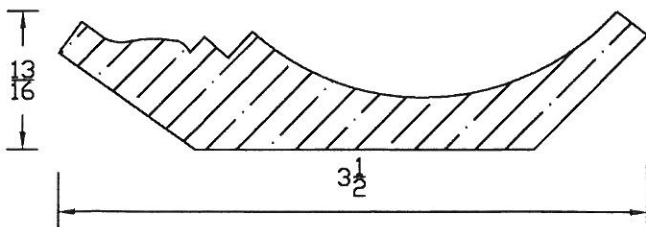

BALSAM MILLWORK CROWNS

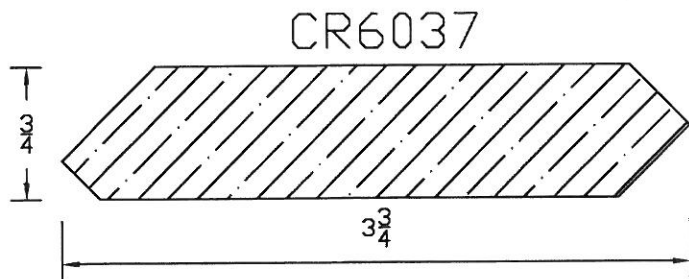
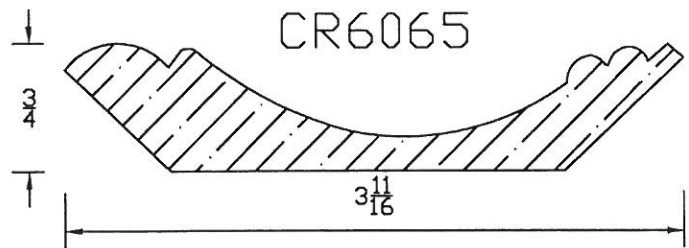
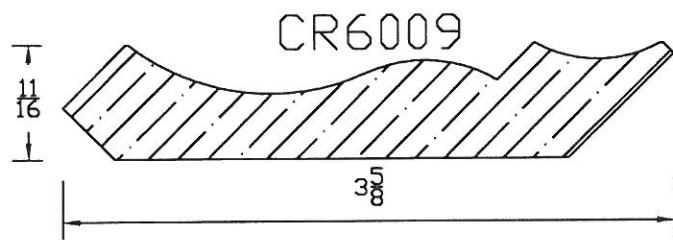
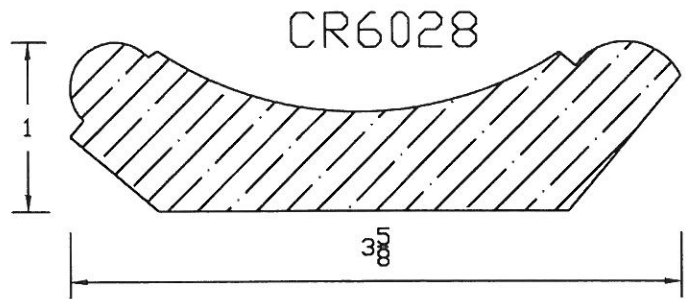
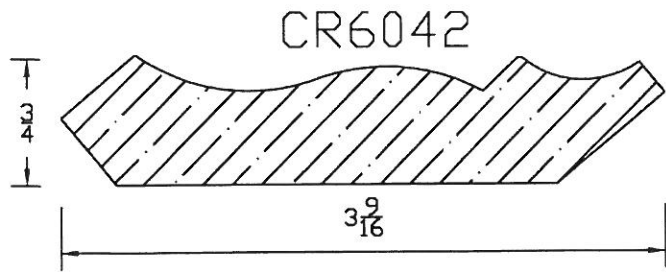

BALSAM MILLWORK CROWNS

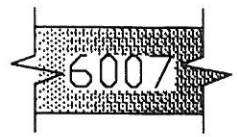
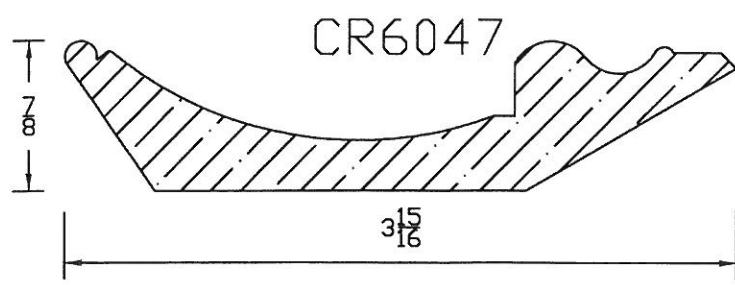
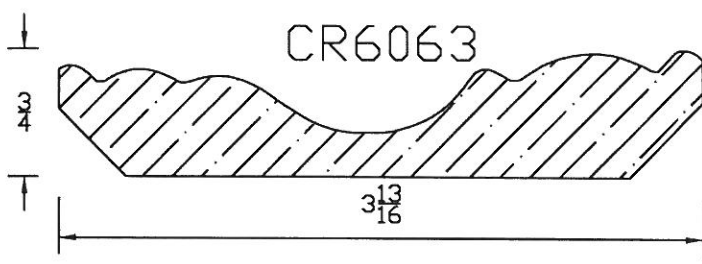
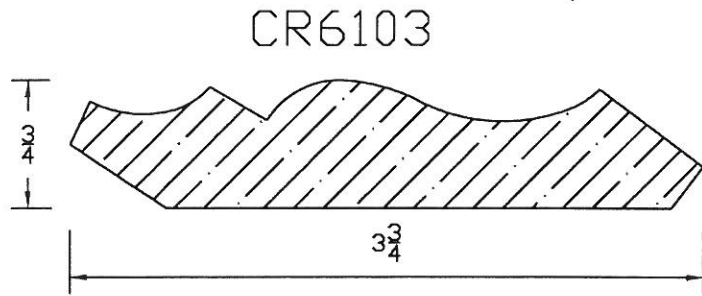
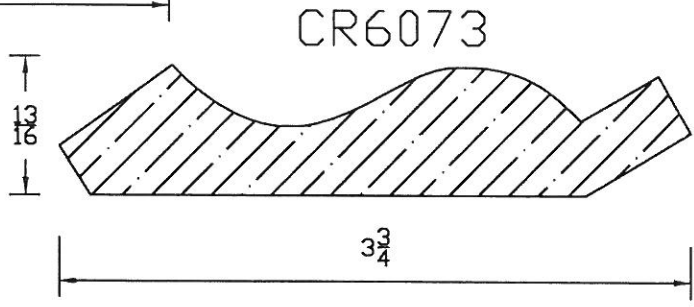
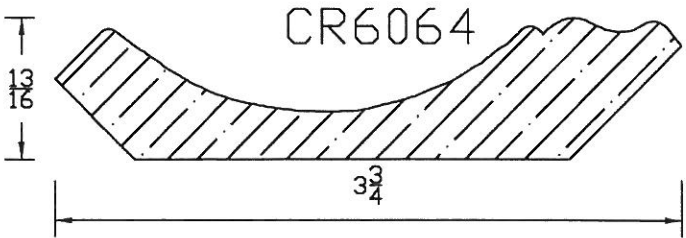

BALSAM MILLWORK CROWNS

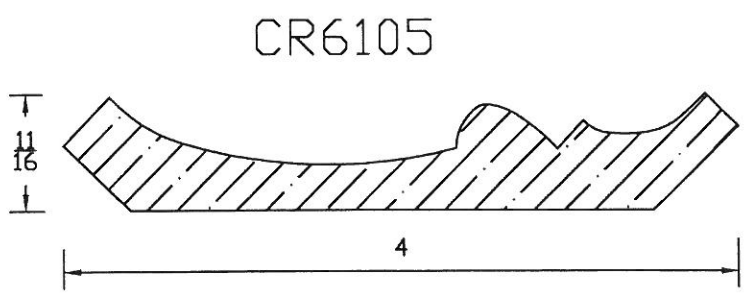
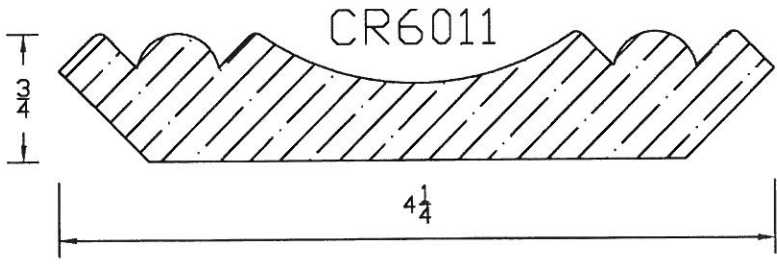
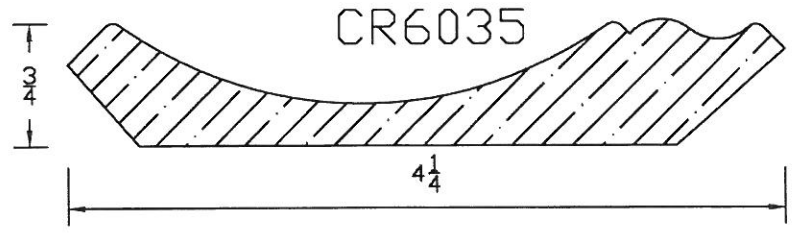
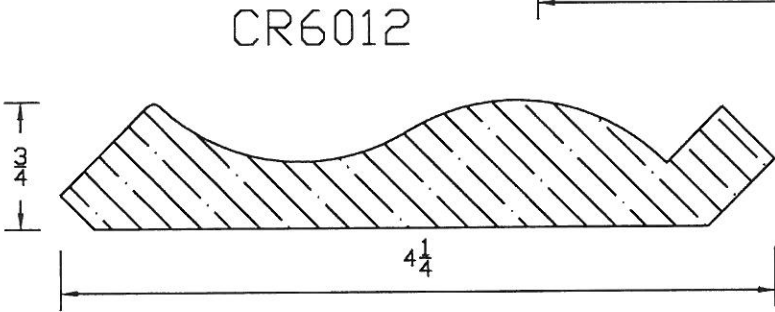
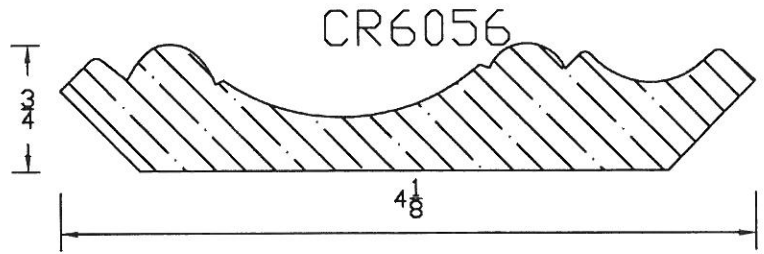

6008



BALSAM MILLWORK CROWNS

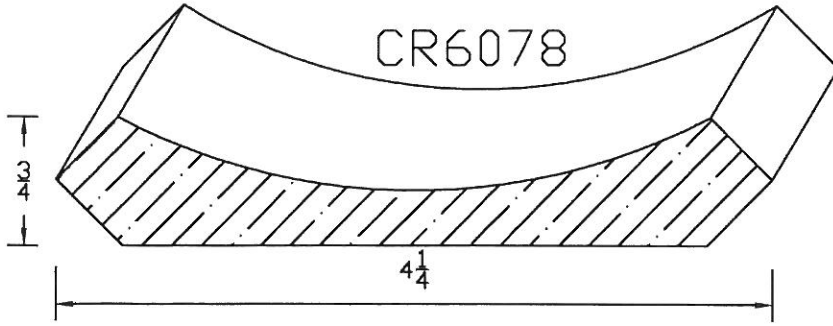

3-D Stocked in up to 17 species

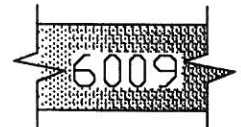
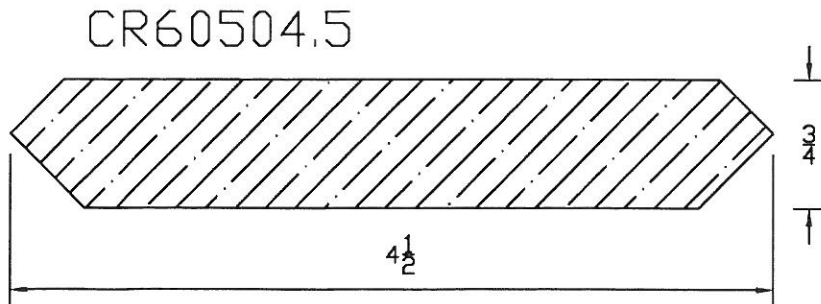
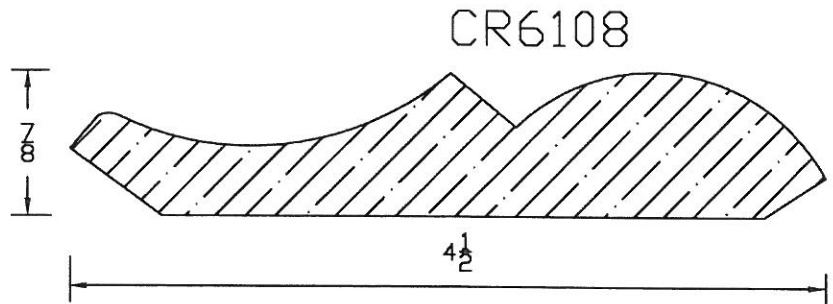
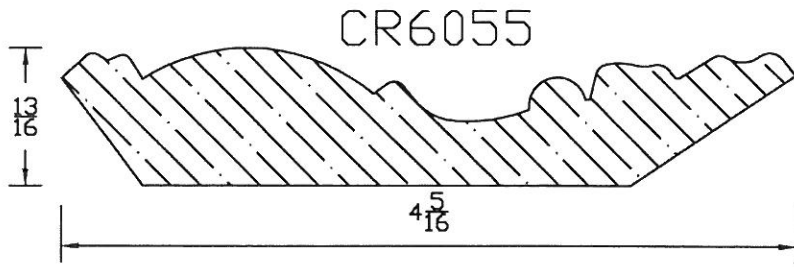
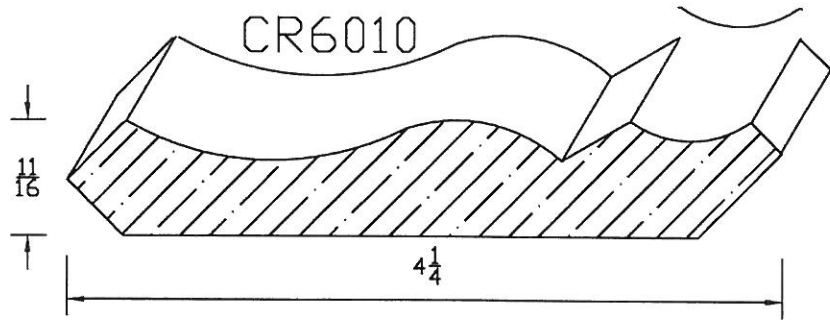

BALSAM MILLWORK CROWNS

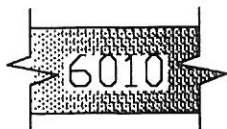
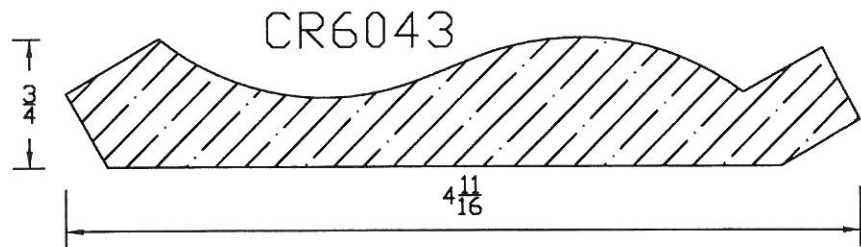
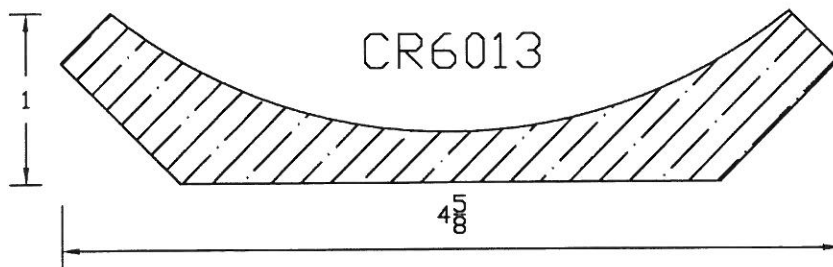
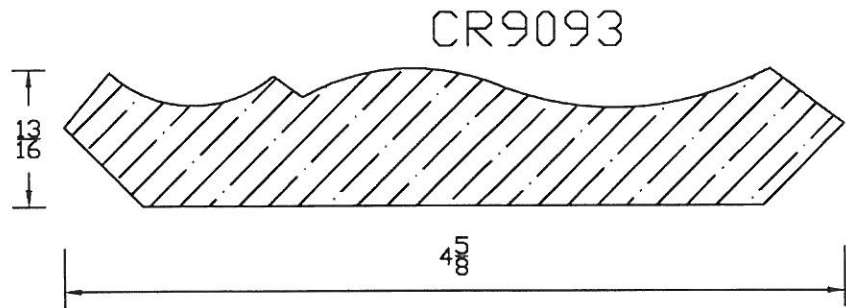
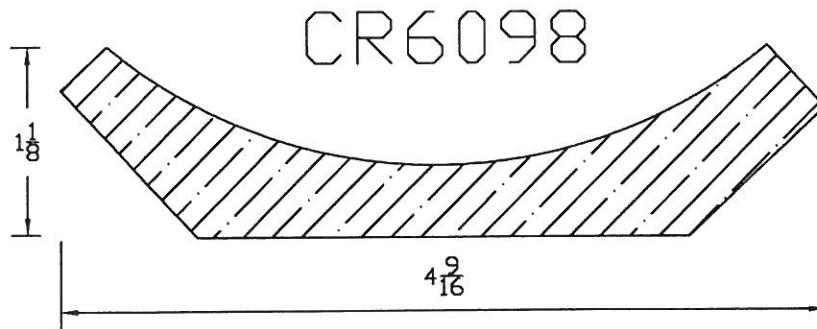
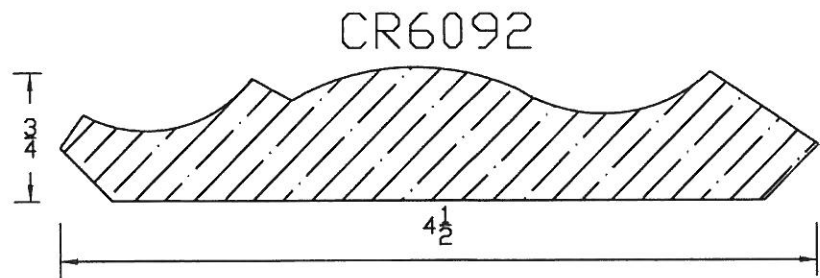

BALSAM MILLWORK CROWNS

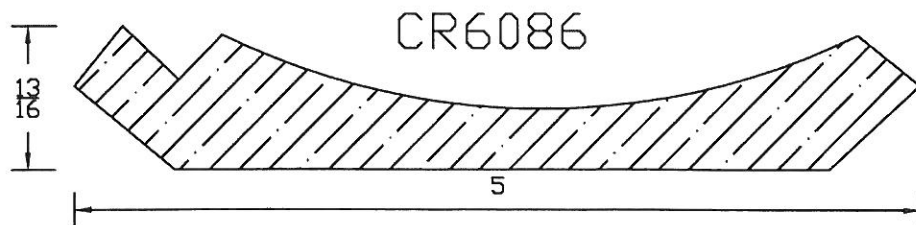
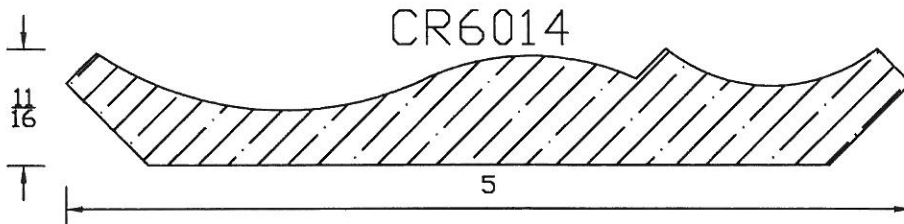
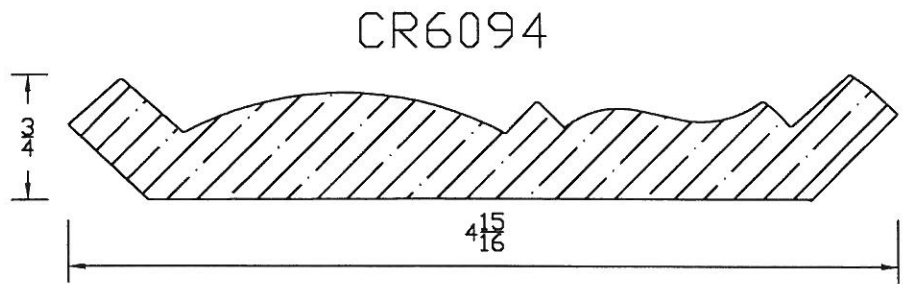
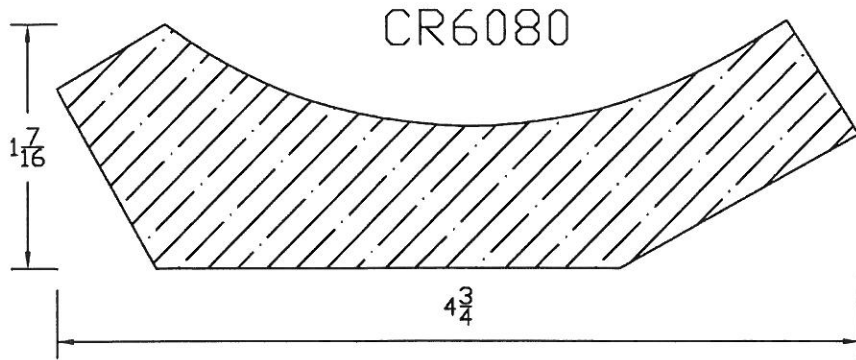

BALSAM MILLWORK CROWNS

CR6106

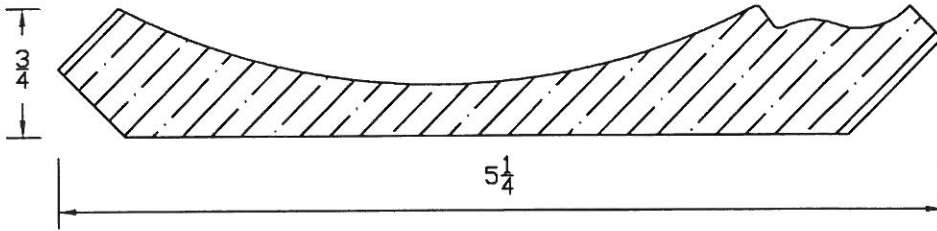

CR6029

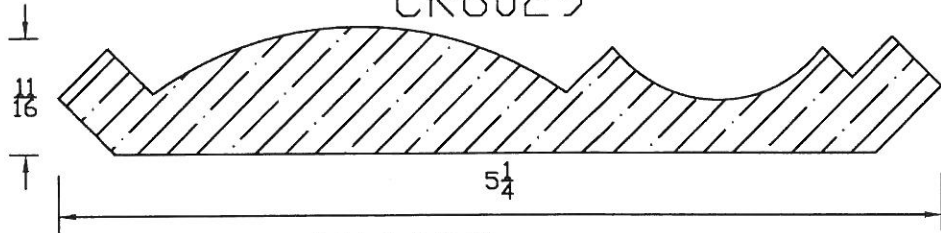

CR6095

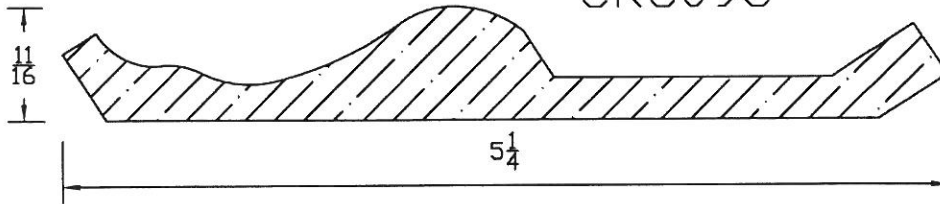

CR6015

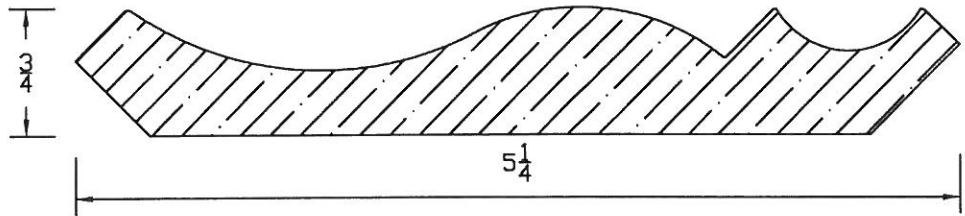

CR6110

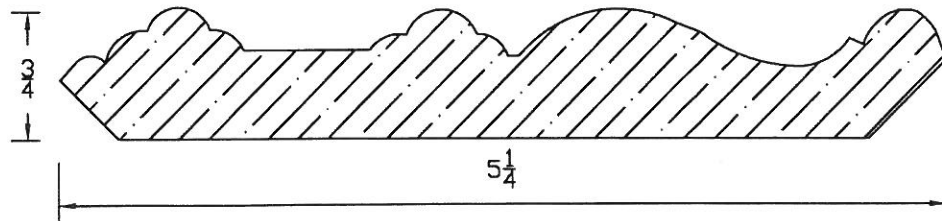

6012

BALSAM MILLWORK CROWNS

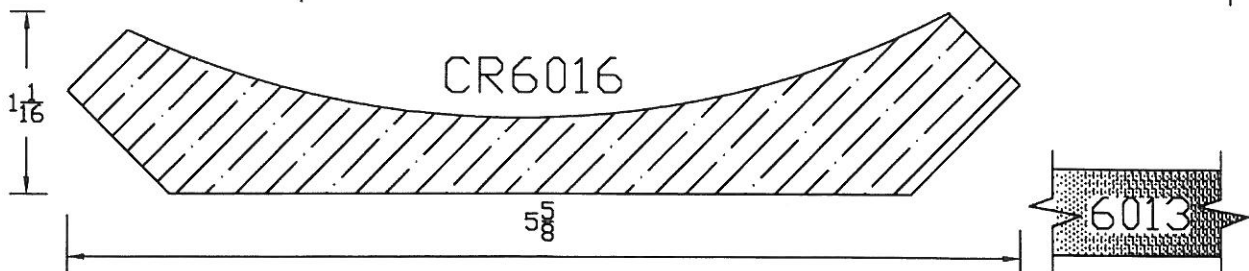
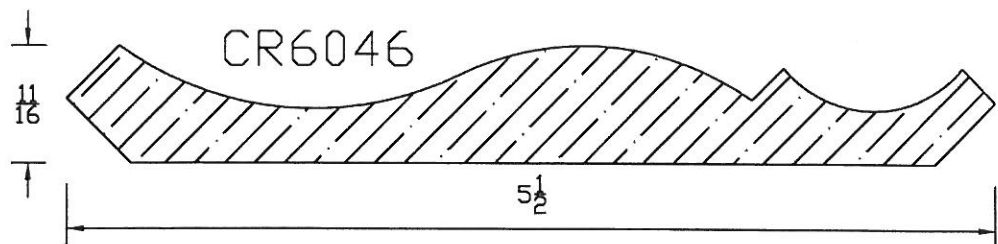
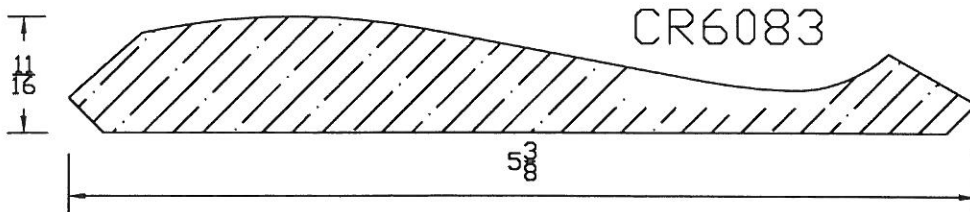
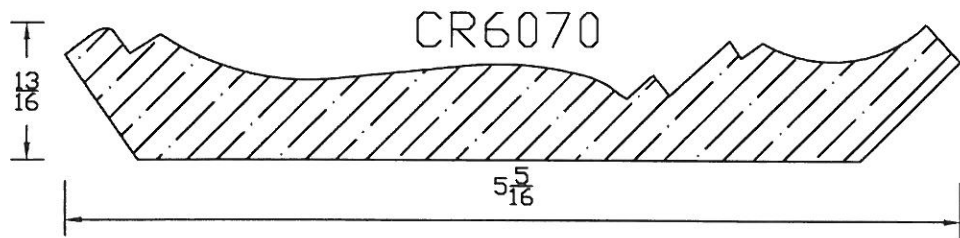
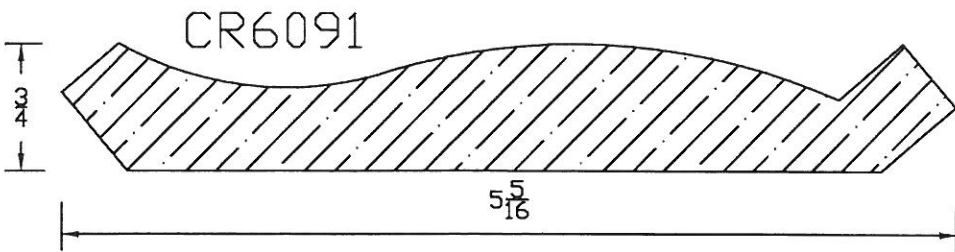
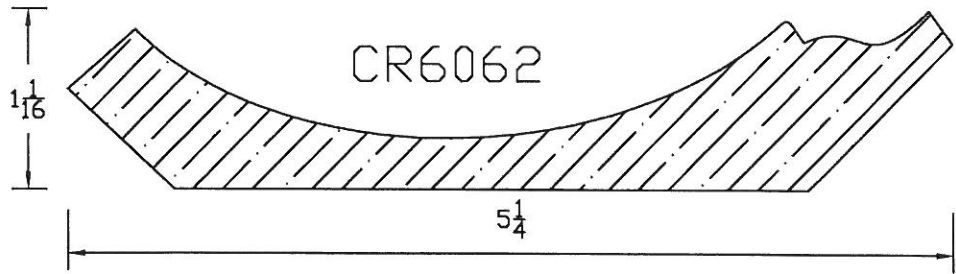

BALSAM MILLWORK CROWNS

CR6104

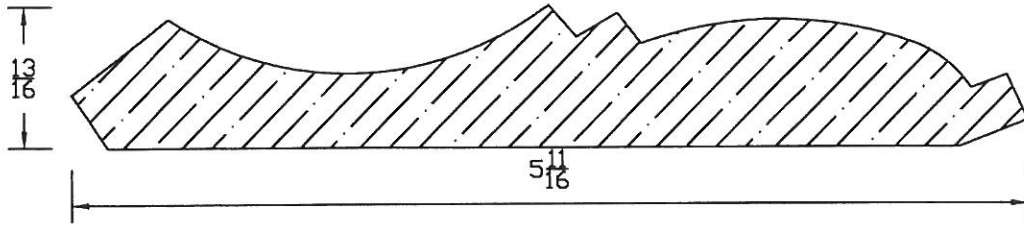

CR6084

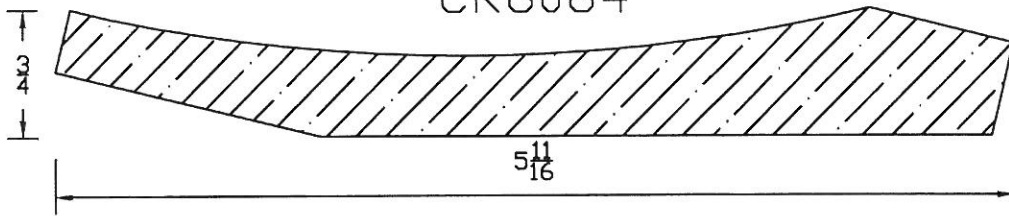

CR6017

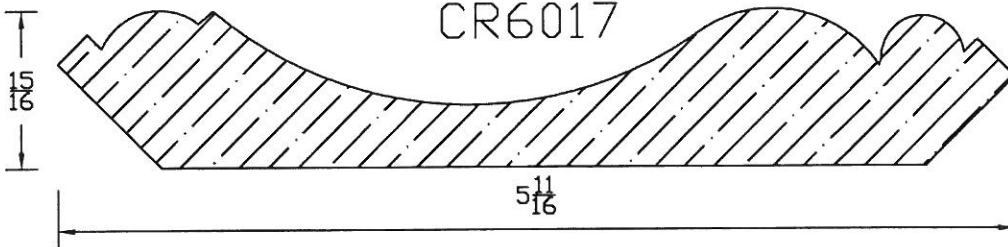

CR6018

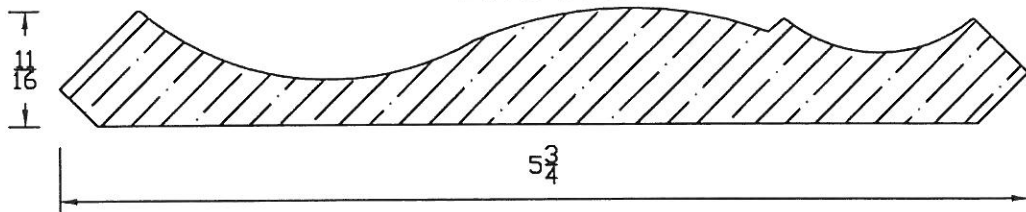

CR6019

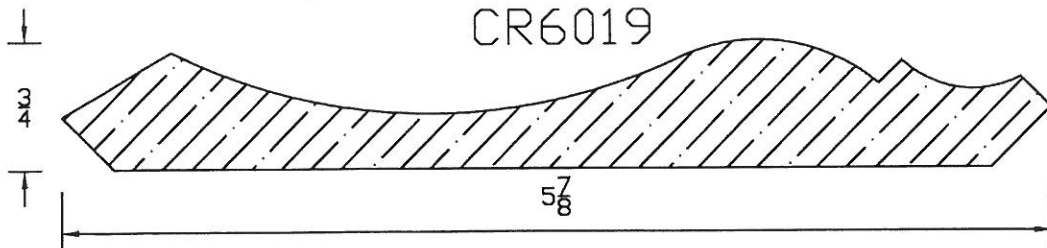

CR6021

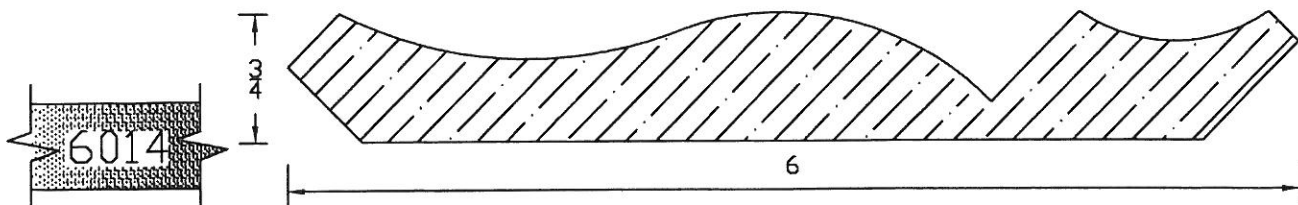

BALSAM MILLWORK CROWNS

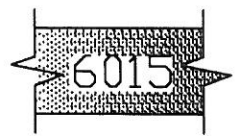
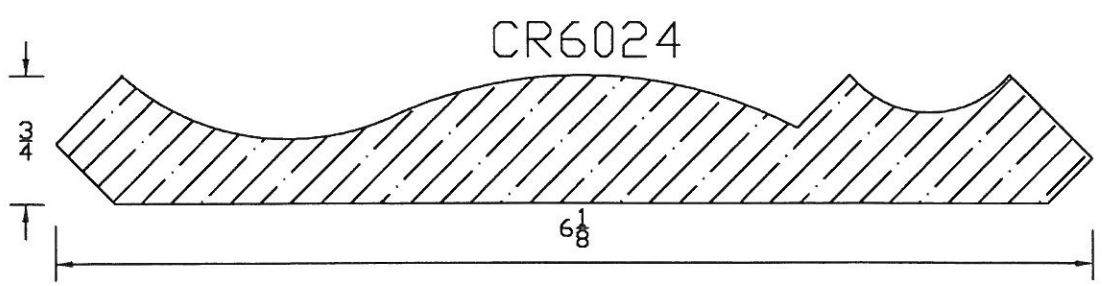
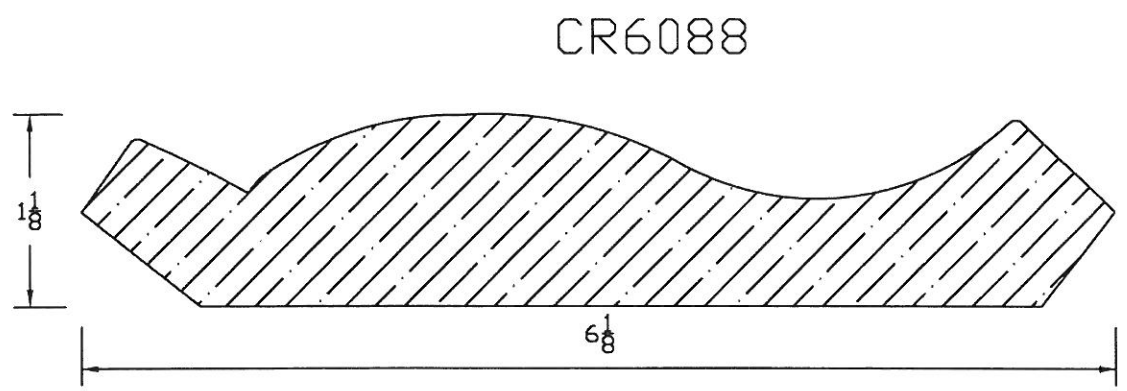
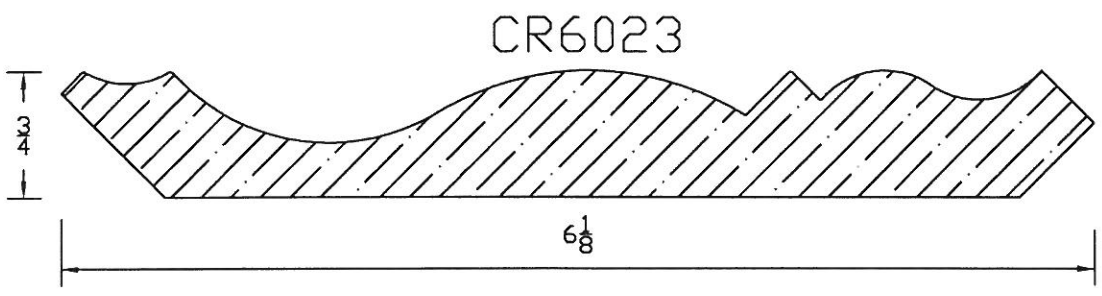
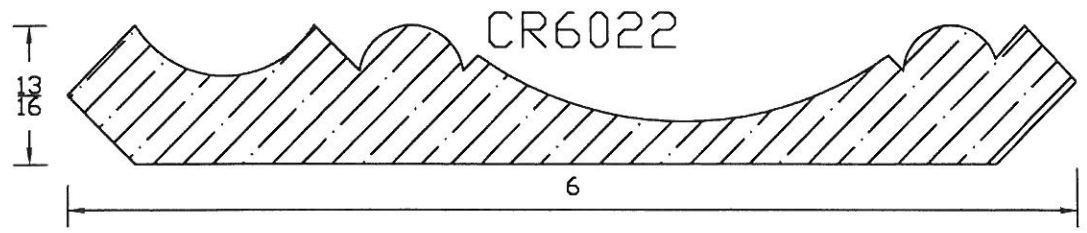

BALSAM MILLWORK CROWNS

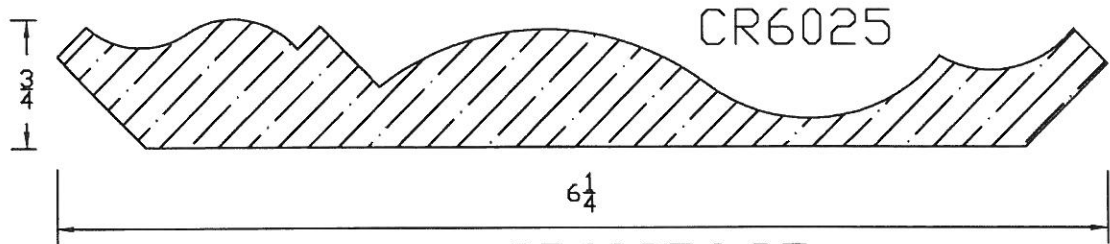

CR60276.25

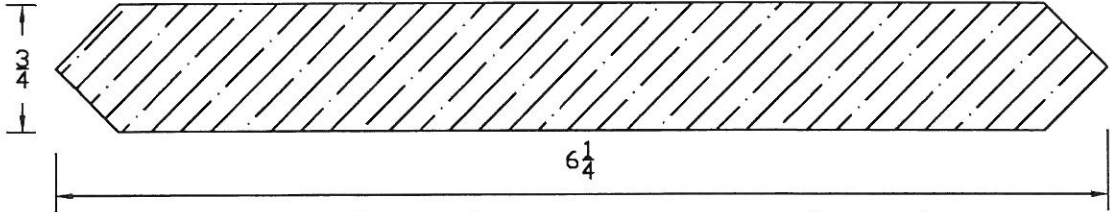

CR60272.25	3/4 X 2 1/4	CR60275.25	3/4 X 5 1/4
CR60273.25	3/4 X 3 1/4	CR60276.25	3/4 X 6 1/4 (ILLUS.)
CR60274.25	3/4 X 4 1/4		

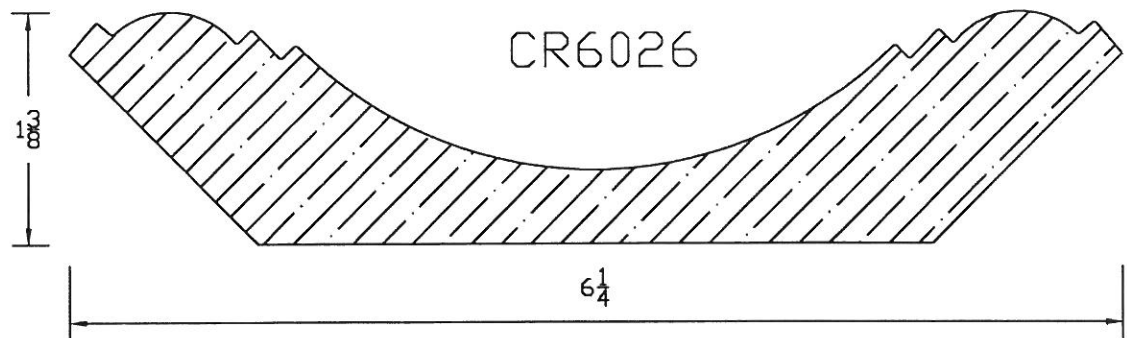

CR6072

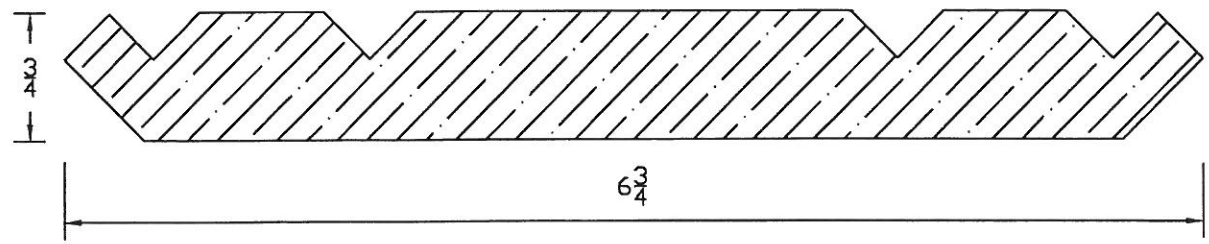



BALSAM MILLWORK CROWNS

CR6057

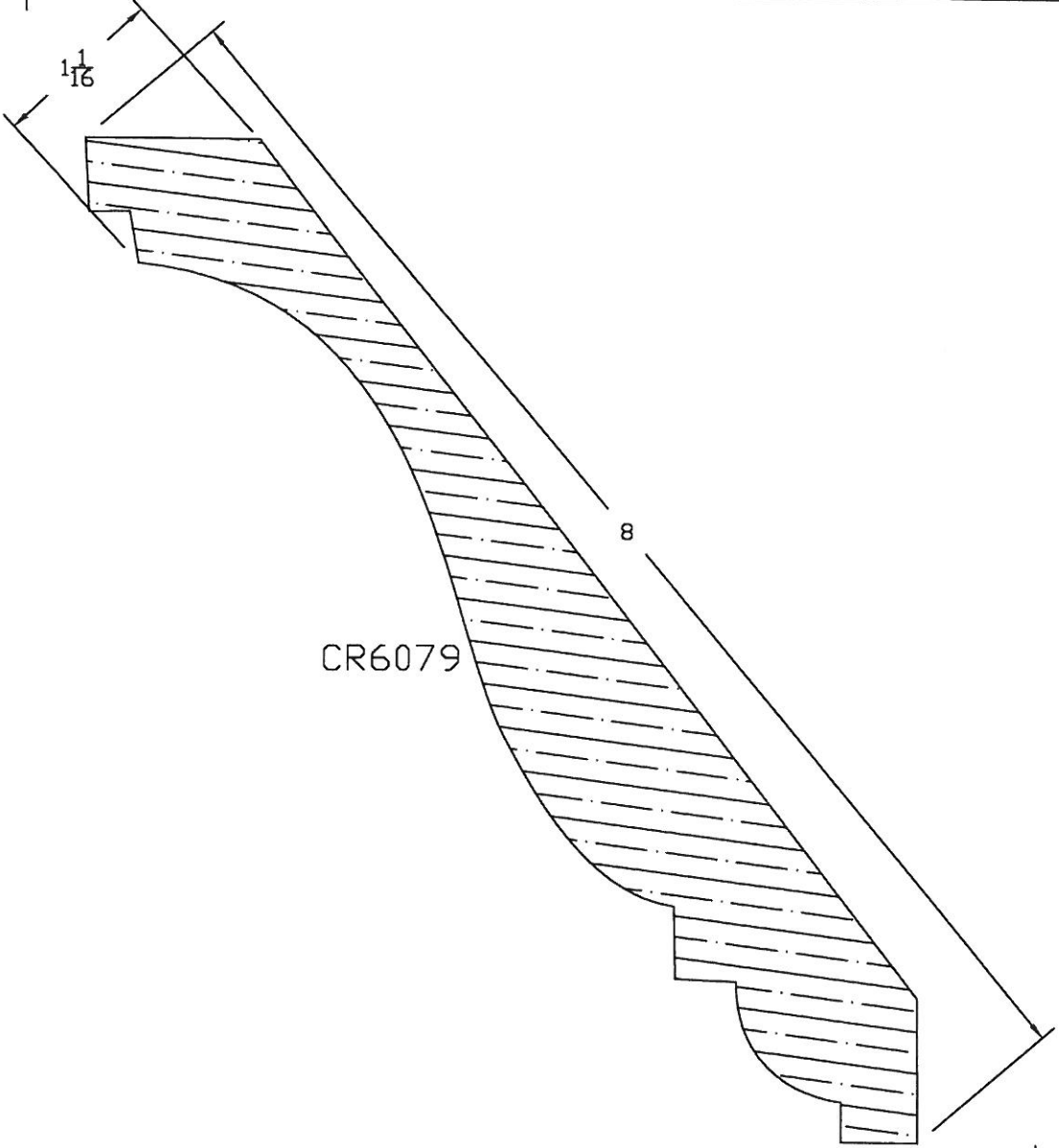
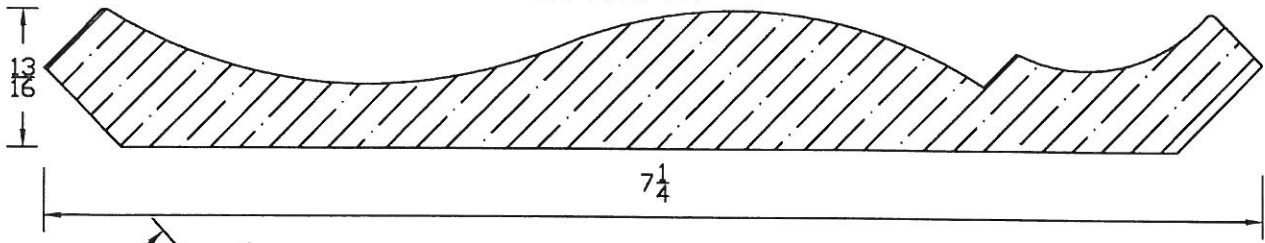

CR6079

6017

BALSAM MILLWORK CROWNS

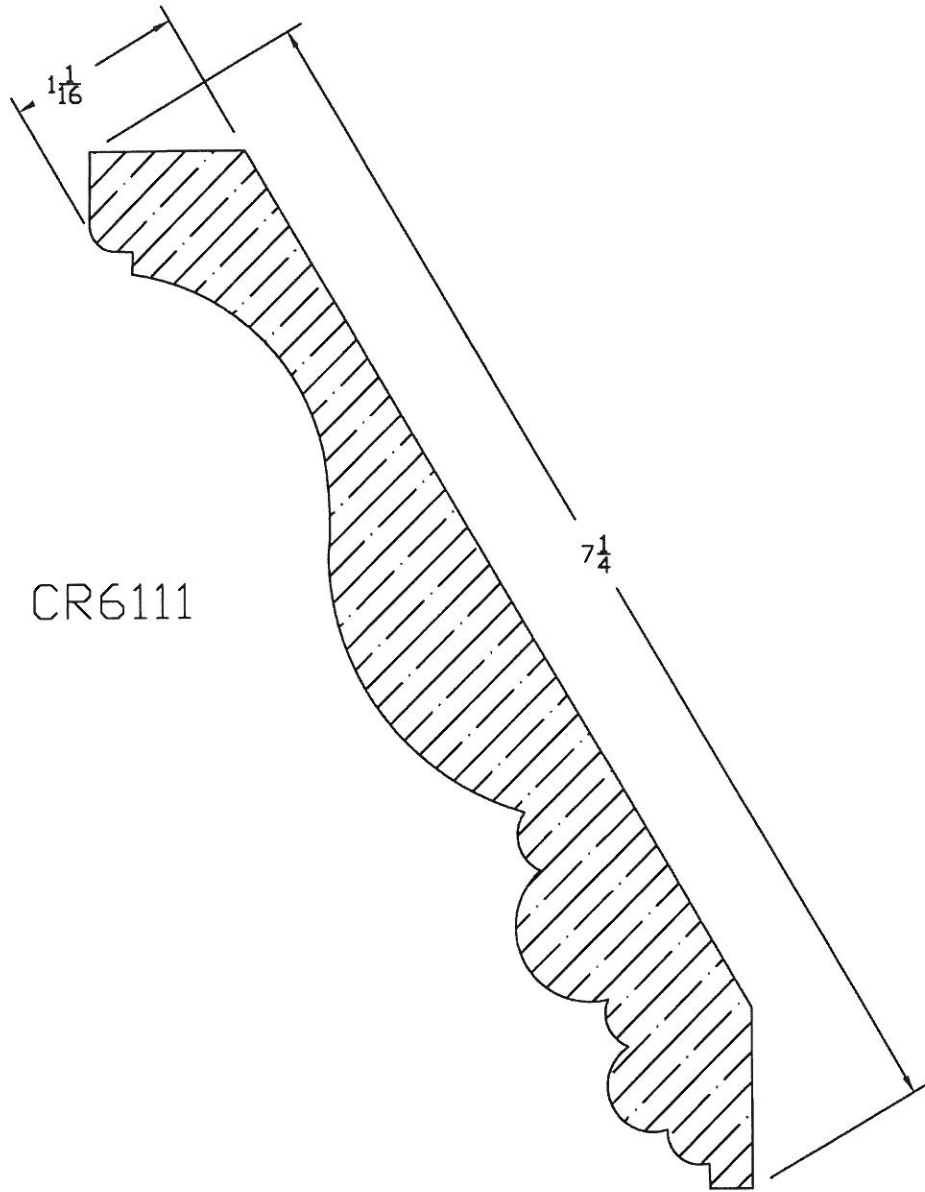

CR6111

6018