

BALSAM MILLWORK CUSTOM ARCH TOP CASING

To order round top casing from Balsam Millwork please provide the following information (you may use a copy of this form to order) :

1. Inside measurement between the side jambs at the point where it meets the sill of the lower window unit. (DIMENSION "A")
2. Inside measurement between the bottom of sill line to the top of the jamb in the center of the arch or radius. (DIMENSION "B")
3. The amount of reveal needed between inside of jamb to edge of casing. If reveal is not specified, we will produce with a 3/16" reveal.

"A" DIMENSION _____

"B" DIMENSION _____

REVEAL SIZE _____

MOULDING PATTERN _____

WOOD SPECIES _____

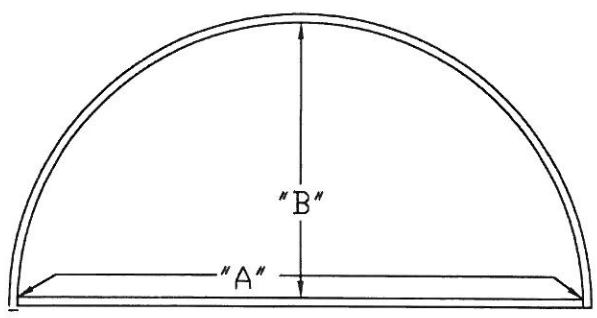

NOTE: The information provided will allow us to calculate the radius to these points. It is normal to see slight variations in the radius of the window jamb, on occasion a slight variation may occur in the trim but this is not typical. The normal variation is $\pm 1/16"$.

OPTIONAL INFO IF AVAILABLE:

WINDOW MANUFACTURER _____

WINDOW ID NUMBER _____

AN ACTUAL TEMPLATE IS ALWAYS HELPFUL AND REQUIRED FOR ALL ELLIPTICAL ARCHES. IF YOUR ARCH IS NOT A TRUE RADIUS WE MUST HAVE A TEMPLATE WITH ORDER.



BALSAM MILLWORK $\frac{1}{8}$ " RADIUS CASING

EXAMPLE: C23.75
 C23 = PATTERN
 .75 = THICKNESS

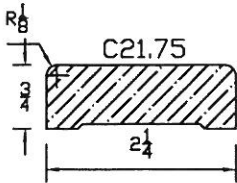

C21.4375 = $\frac{7}{16}$ THICK
 C21.50 = $\frac{1}{2}$ THICK
 C21.5625 = $\frac{9}{16}$ THICK
 C21.625 = $\frac{5}{8}$ THICK
 C21.6875 = $\frac{11}{16}$ THICK
 C21.75 = $\frac{3}{4}$ THICK (ILLUS.)

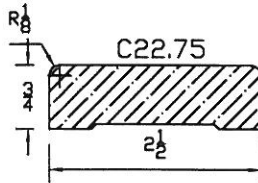

C22.4375 = $\frac{7}{16}$ THICK
 C22.50 = $\frac{1}{2}$ THICK
 C22.5625 = $\frac{9}{16}$ THICK
 C22.625 = $\frac{5}{8}$ THICK
 C22.6875 = $\frac{11}{16}$ THICK
 C22.75 = $\frac{3}{4}$ THICK (ILLUS.)

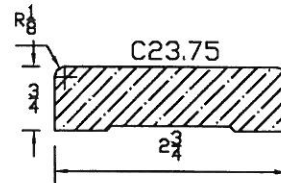

C23.4375 = $\frac{7}{16}$ THICK
 C23.50 = $\frac{1}{2}$ THICK
 C23.5625 = $\frac{9}{16}$ THICK
 C23.625 = $\frac{5}{8}$ THICK
 C23.6875 = $\frac{11}{16}$ THICK
 C23.75 = $\frac{3}{4}$ THICK (ILLUS.)

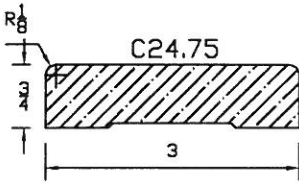

C24.4375 = $\frac{7}{16}$ THICK
 C24.50 = $\frac{1}{2}$ THICK
 C24.5625 = $\frac{9}{16}$ THICK
 C24.625 = $\frac{5}{8}$ THICK
 C24.6875 = $\frac{11}{16}$ THICK
 C24.75 = $\frac{3}{4}$ THICK (ILLUS.)

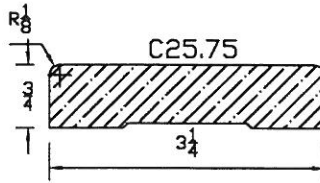

C25.4375 = $\frac{7}{16}$ THICK
 C25.50 = $\frac{1}{2}$ THICK
 C25.5625 = $\frac{9}{16}$ THICK
 C25.625 = $\frac{5}{8}$ THICK
 C25.6875 = $\frac{11}{16}$ THICK
 C25.75 = $\frac{3}{4}$ THICK (ILLUS.)

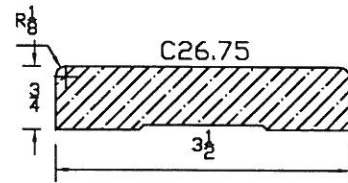

C26.4375 = $\frac{7}{16}$ THICK
 C26.50 = $\frac{1}{2}$ THICK
 C26.5625 = $\frac{9}{16}$ THICK
 C26.625 = $\frac{5}{8}$ THICK
 C26.6875 = $\frac{11}{16}$ THICK
 C26.75 = $\frac{3}{4}$ THICK (ILLUS.)

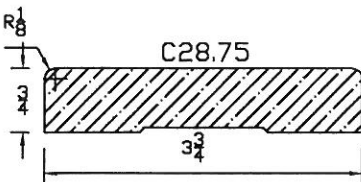

C28.4375 = $\frac{7}{16}$ THICK
 C28.50 = $\frac{1}{2}$ THICK
 C28.5625 = $\frac{9}{16}$ THICK
 C28.625 = $\frac{5}{8}$ THICK
 C28.6875 = $\frac{11}{16}$ THICK
 C28.75 = $\frac{3}{4}$ THICK (ILLUS.)

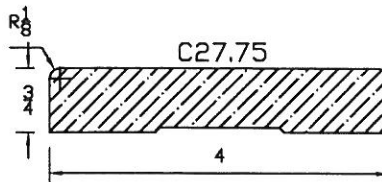

C27.4375 = $\frac{7}{16}$ THICK
 C27.50 = $\frac{1}{2}$ THICK
 C27.5625 = $\frac{9}{16}$ THICK
 C27.625 = $\frac{5}{8}$ THICK
 C27.6875 = $\frac{11}{16}$ THICK
 C27.75 = $\frac{3}{4}$ THICK (ILLUS.)

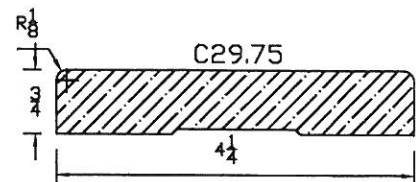

C29.4375 = $\frac{7}{16}$ THICK
 C29.50 = $\frac{1}{2}$ THICK
 C29.5625 = $\frac{9}{16}$ THICK
 C29.625 = $\frac{5}{8}$ THICK
 C29.6875 = $\frac{11}{16}$ THICK
 C29.75 = $\frac{3}{4}$ THICK (ILLUS.)

(Most Case can be modified for thickness some for width)

BALSAM MILLWORK $\frac{1}{4}$ " RADIUS CASING

EXAMPLE: C33.75
 C33 = PATTERN
 .75 = THICKNESS

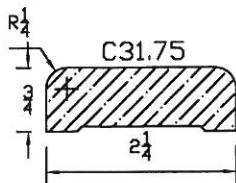

C31.4375 = $\frac{7}{16}$ THICK
 C31.50 = $\frac{1}{2}$ THICK
 C31.5625 = $\frac{9}{16}$ THICK
 C31.625 = $\frac{5}{8}$ THICK
 C31.6875 = $\frac{11}{16}$ THICK
 C31.75 = $\frac{3}{4}$ THICK (ILLUS.)

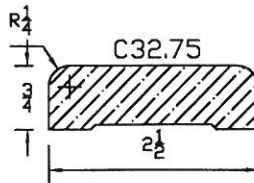

C32.4375 = $\frac{7}{16}$ THICK
 C32.50 = $\frac{1}{2}$ THICK
 C32.5625 = $\frac{9}{16}$ THICK
 C32.625 = $\frac{5}{8}$ THICK
 C32.6875 = $\frac{11}{16}$ THICK
 C32.75 = $\frac{3}{4}$ THICK (ILLUS.)

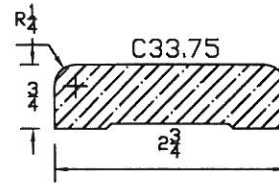

C33.4375 = $\frac{7}{16}$ THICK
 C33.50 = $\frac{1}{2}$ THICK
 C33.5625 = $\frac{9}{16}$ THICK
 C33.625 = $\frac{5}{8}$ THICK
 C33.6875 = $\frac{11}{16}$ THICK
 C33.75 = $\frac{3}{4}$ THICK (ILLUS.)

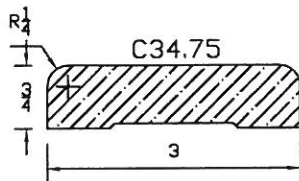

C34.4375 = $\frac{7}{16}$ THICK
 C34.50 = $\frac{1}{2}$ THICK
 C34.5625 = $\frac{9}{16}$ THICK
 C34.625 = $\frac{5}{8}$ THICK
 C34.6875 = $\frac{11}{16}$ THICK
 C34.75 = $\frac{3}{4}$ THICK (ILLUS.)

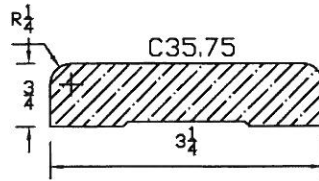

C35.4375 = $\frac{7}{16}$ THICK
 C35.50 = $\frac{1}{2}$ THICK
 C35.5625 = $\frac{9}{16}$ THICK
 C35.625 = $\frac{5}{8}$ THICK
 C35.6875 = $\frac{11}{16}$ THICK
 C35.75 = $\frac{3}{4}$ THICK (ILLUS.)

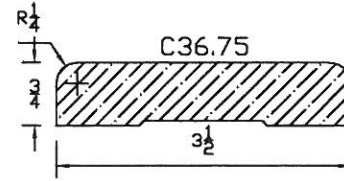

C36.4375 = $\frac{7}{16}$ THICK
 C36.50 = $\frac{1}{2}$ THICK
 C36.5625 = $\frac{9}{16}$ THICK
 C36.625 = $\frac{5}{8}$ THICK
 C36.6875 = $\frac{11}{16}$ THICK
 C36.75 = $\frac{3}{4}$ THICK (ILLUS.)

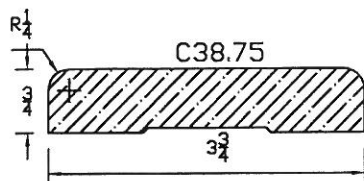

C38.4375 = $\frac{7}{16}$ THICK
 C38.50 = $\frac{1}{2}$ THICK
 C38.5625 = $\frac{9}{16}$ THICK
 C38.625 = $\frac{5}{8}$ THICK
 C38.6875 = $\frac{11}{16}$ THICK
 C38.75 = $\frac{3}{4}$ THICK (ILLUS.)

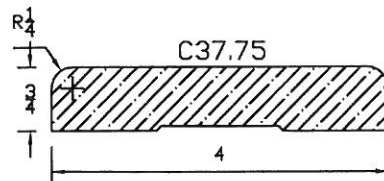

C37.4375 = $\frac{7}{16}$ THICK
 C37.50 = $\frac{1}{2}$ THICK
 C37.5625 = $\frac{9}{16}$ THICK
 C37.625 = $\frac{5}{8}$ THICK
 C37.6875 = $\frac{11}{16}$ THICK
 C37.75 = $\frac{3}{4}$ THICK (ILLUS.)

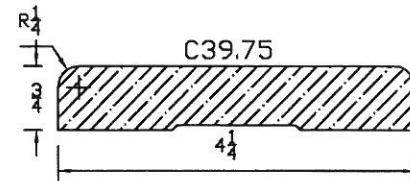

C39.4375 = $\frac{7}{16}$ THICK
 C39.50 = $\frac{1}{2}$ THICK
 C39.5625 = $\frac{9}{16}$ THICK
 C39.625 = $\frac{5}{8}$ THICK
 C39.6875 = $\frac{11}{16}$ THICK
 C39.75 = $\frac{3}{4}$ THICK (ILLUS.)

BALSAM MILLWORK CASING

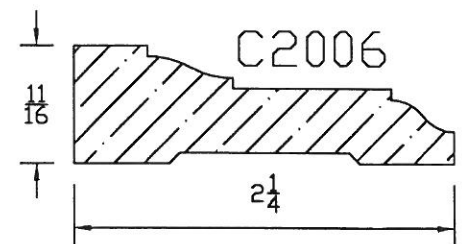
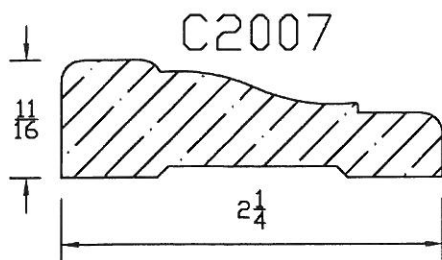
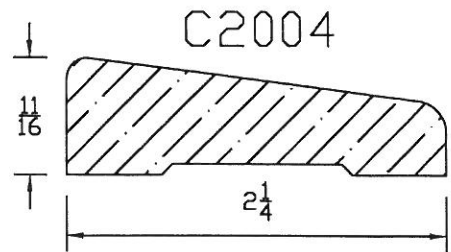
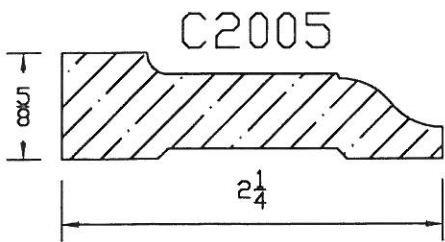
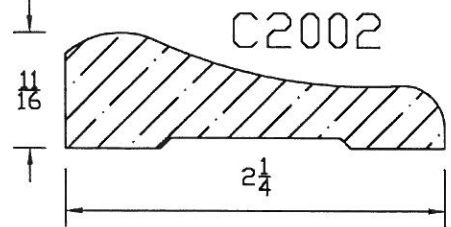
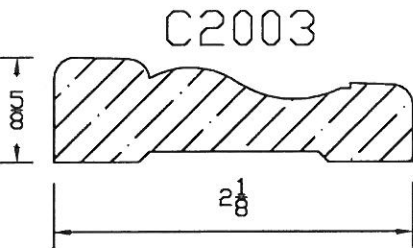
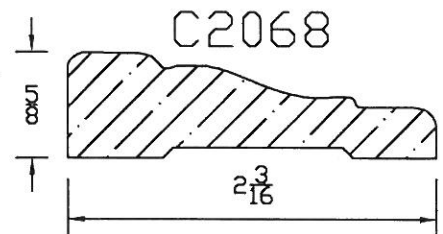
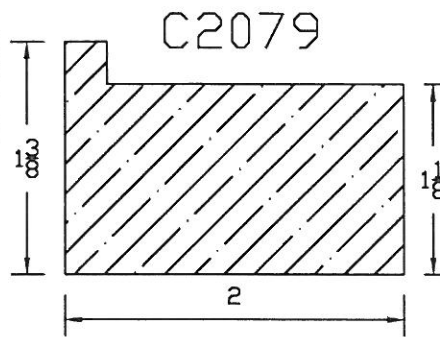
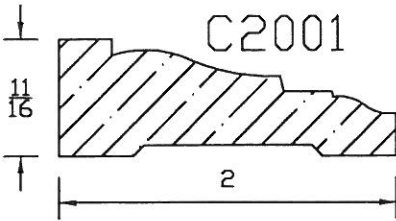
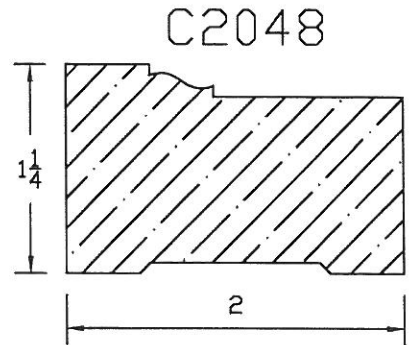
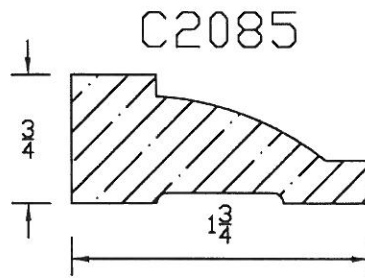
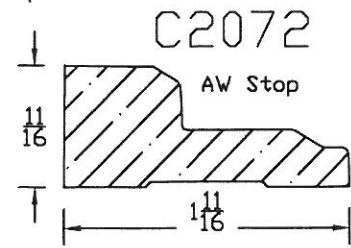

(Most Case can be modified for thickness some for width)



BALSAM MILLWORK CASING

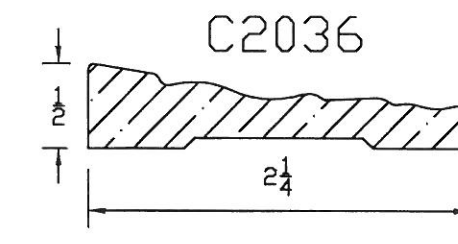
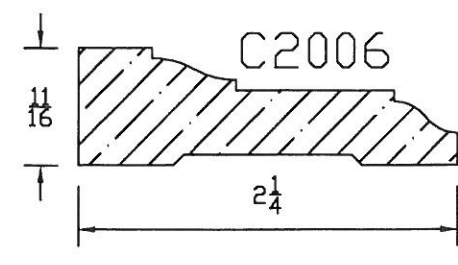
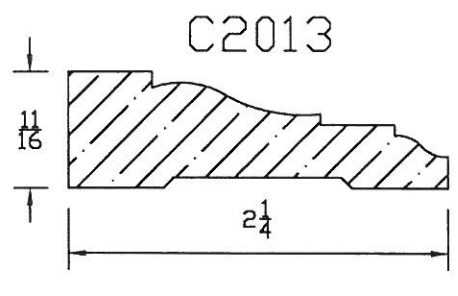
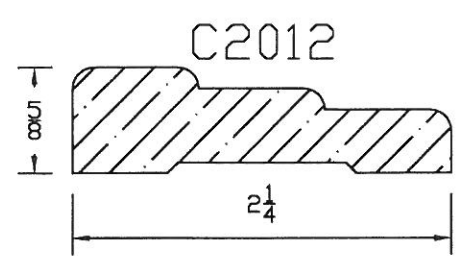
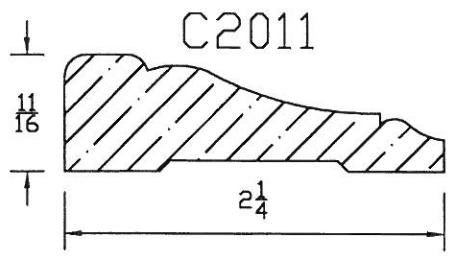
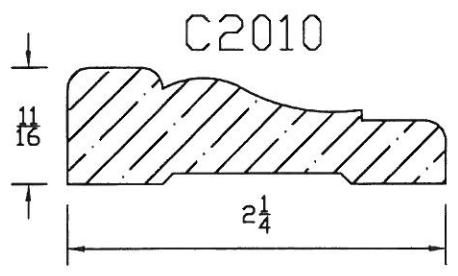
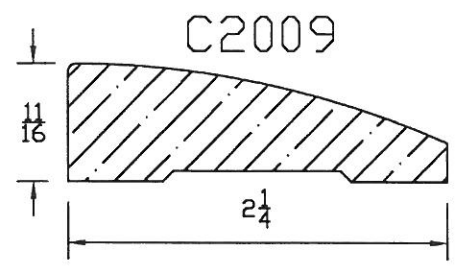
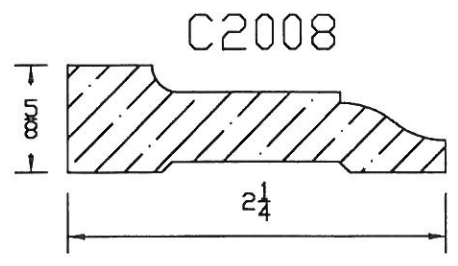

(Most Case can be modified for thickness some for width)

BALSAM MILLWORK CASING

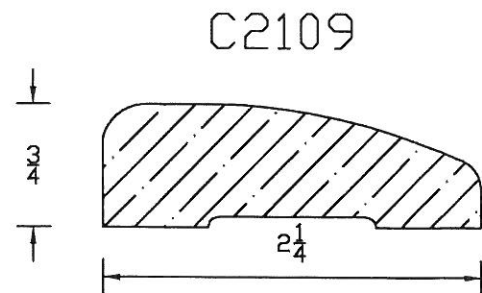
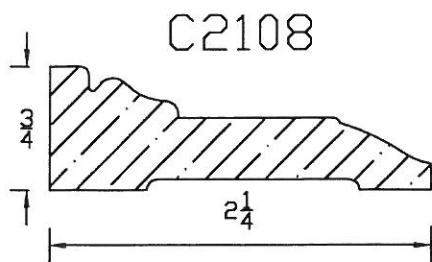
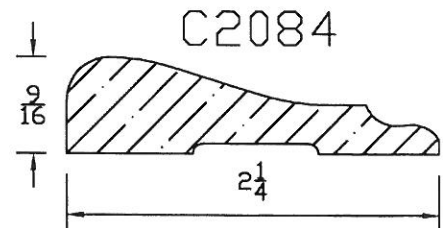
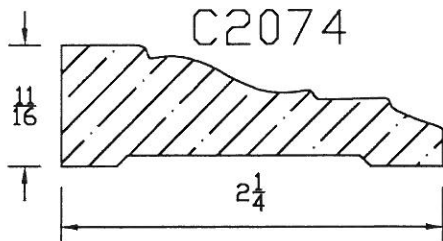
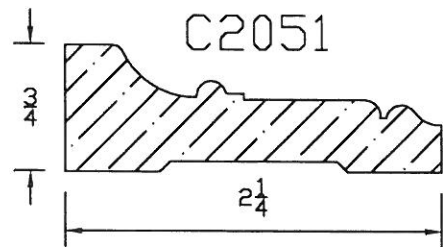
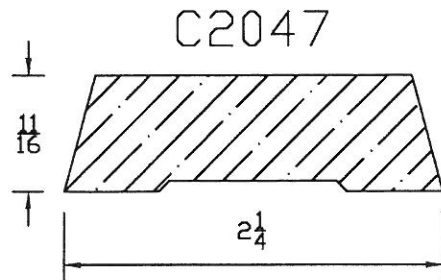
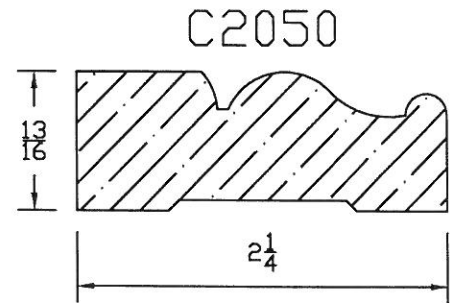
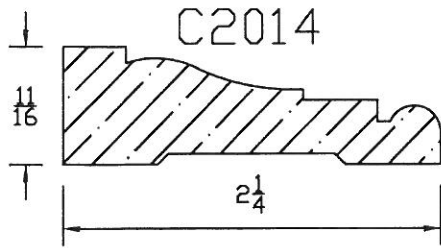

(Most Case can be modified for thickness some for width)

BALSAM MILLWORK CASING

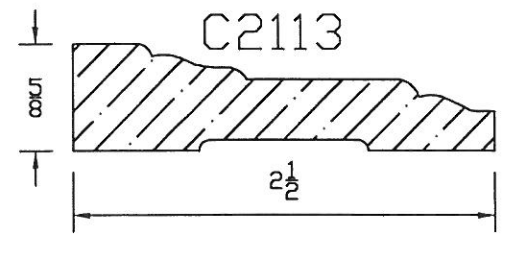
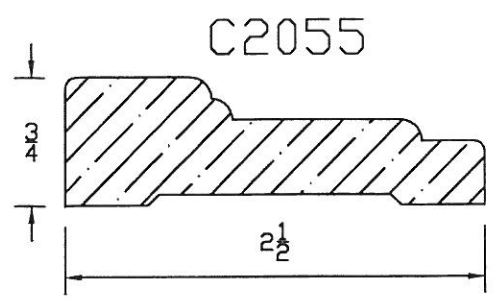
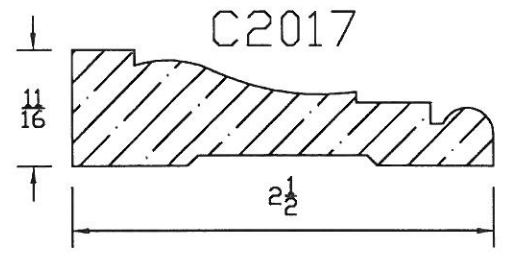
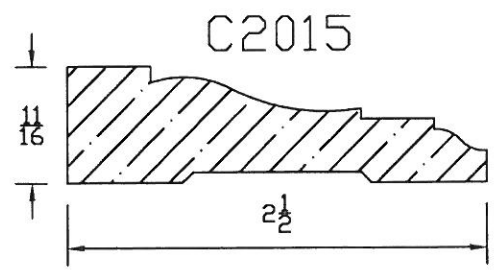
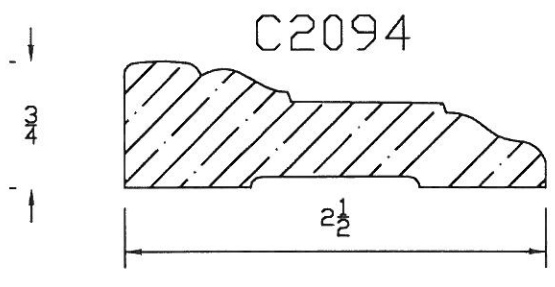
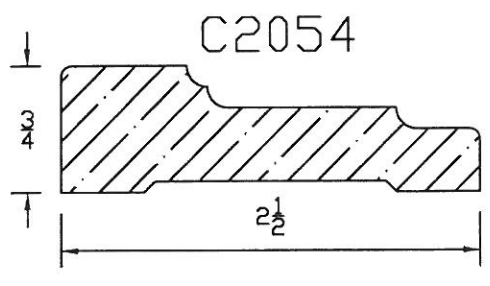
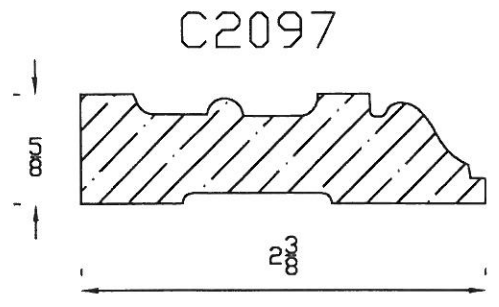
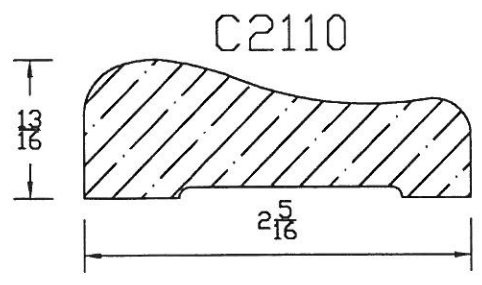

(Most Case can be modified for thickness some for width)

BALSAM MILLWORK CASING

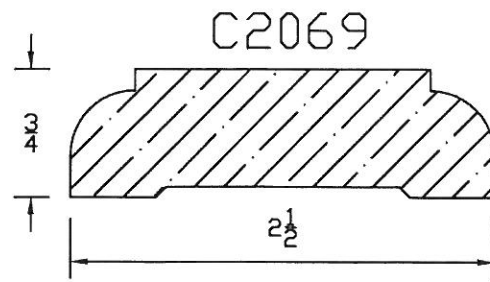
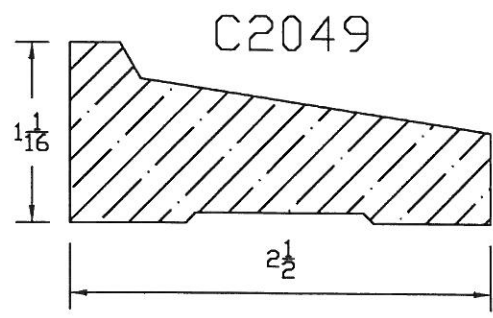
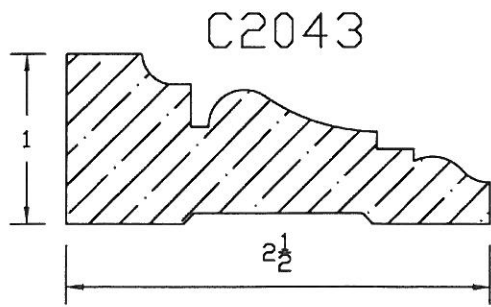
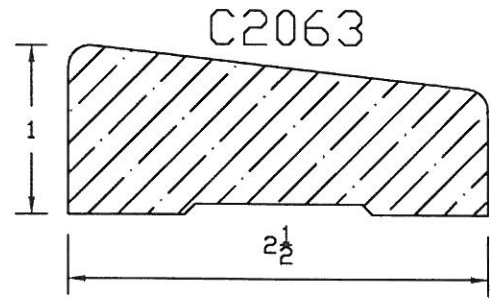
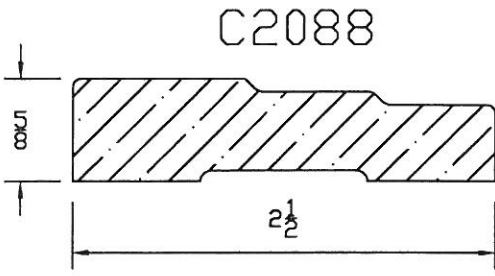
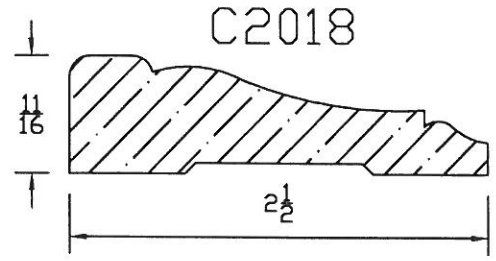
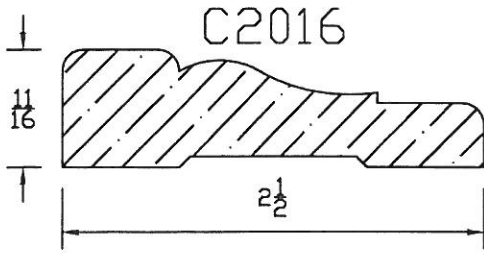

(Most Case can be modified for thickness some for width)



BALSAM MILLWORK CASING

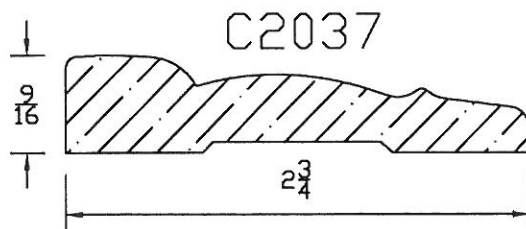
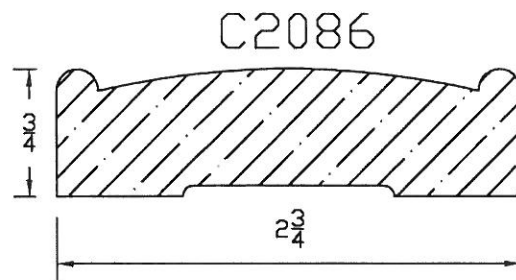
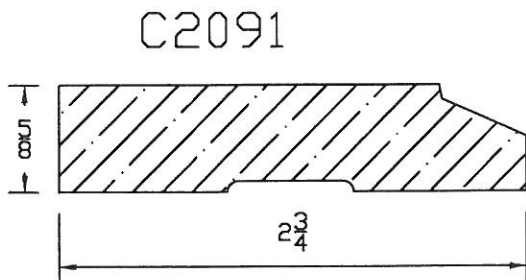
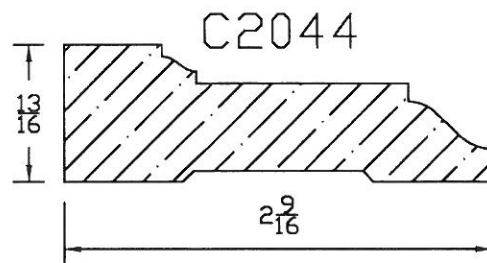
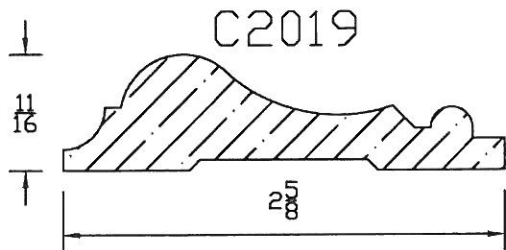
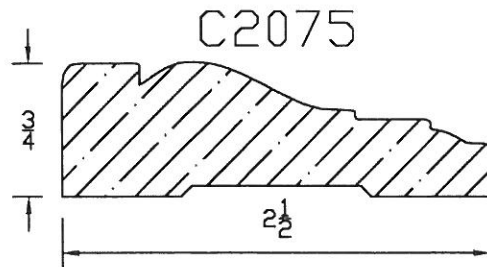
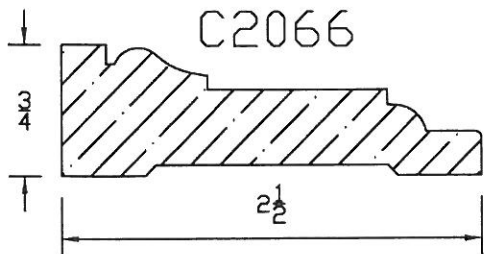

(Most Case can be modified for thickness some for width)

BALSAM MILLWORK CASING

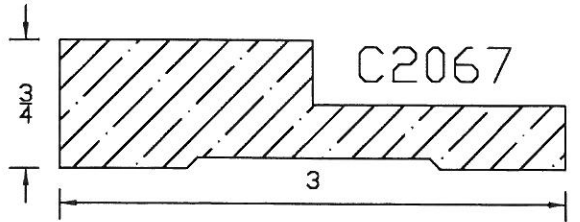
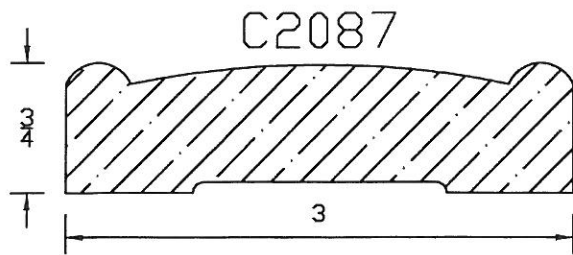
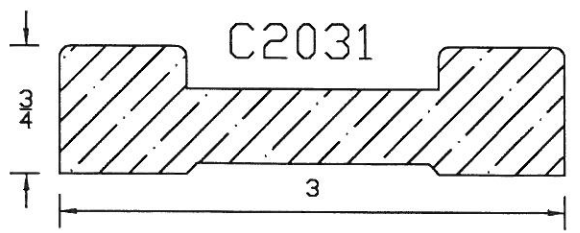
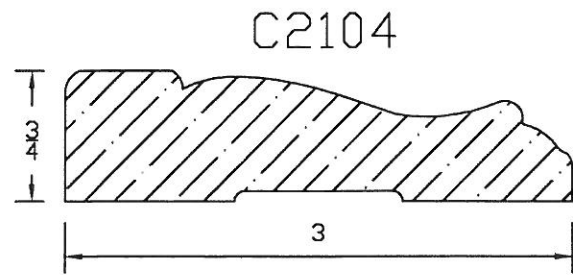
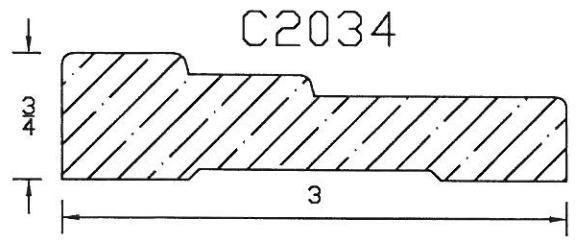
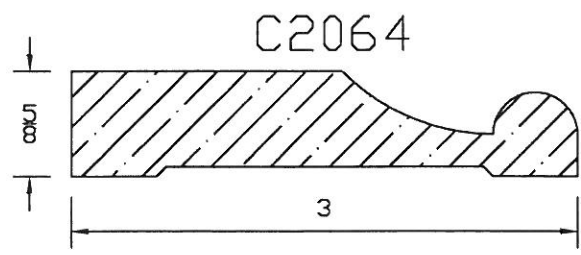
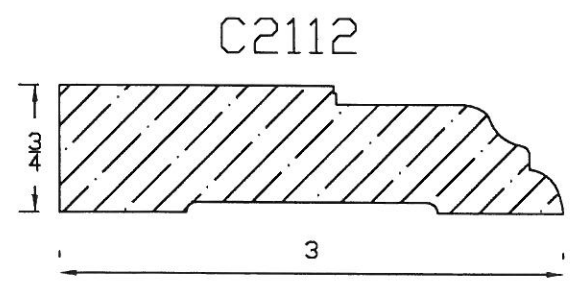
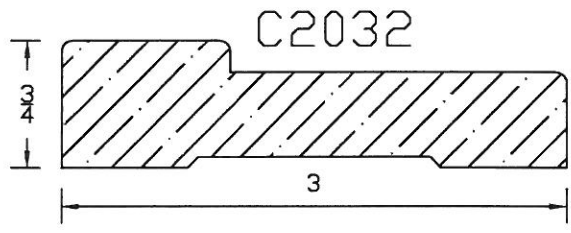
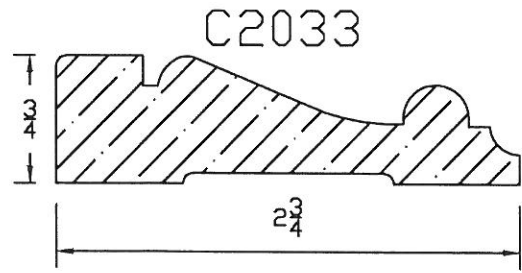
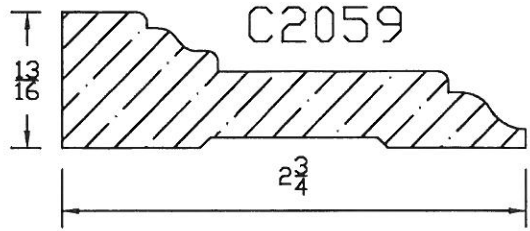

(Most Case can be modified for thickness some for width)

BALSAM MILLWORK CASING

C2098

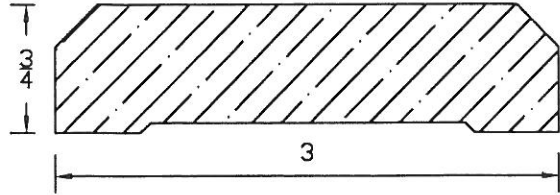

C2083

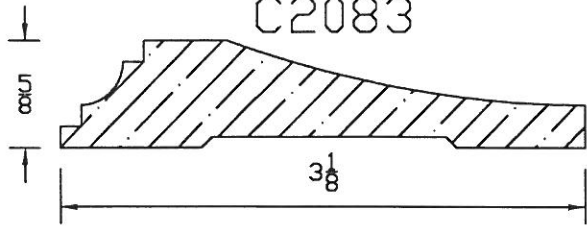

C2035

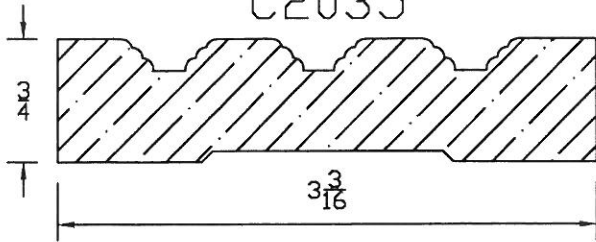

C2039

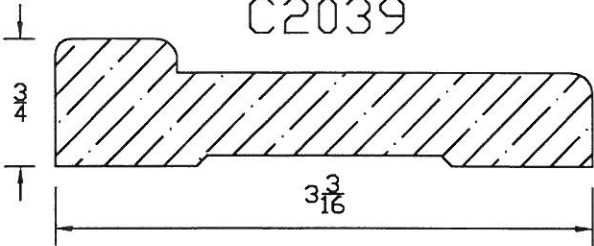

C2081

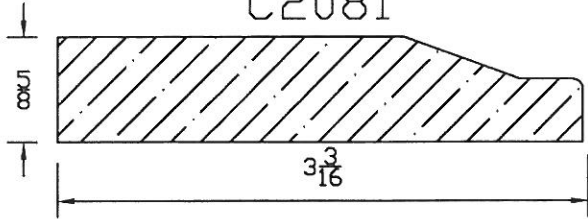

C2071

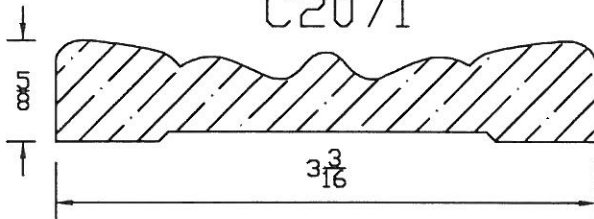

C2020

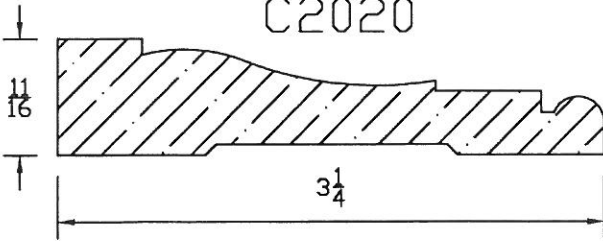

C2056

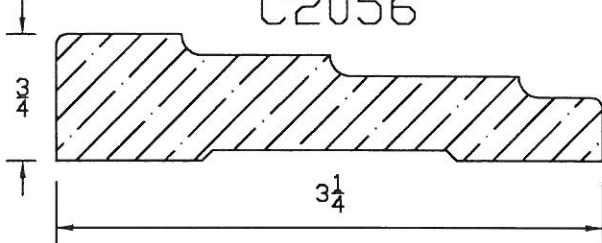

C2057

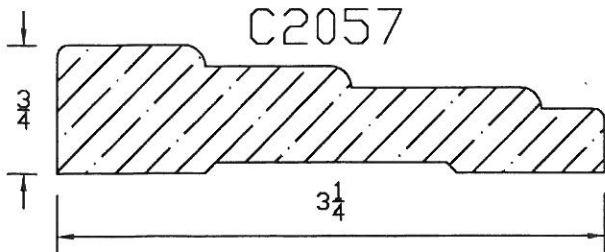

C2107

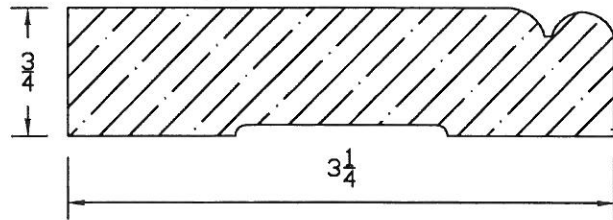

C2099

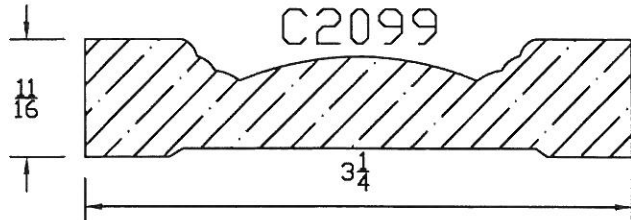

2010

(Most Case can be modified for thickness some for width)

BALSAM MILLWORK CASING

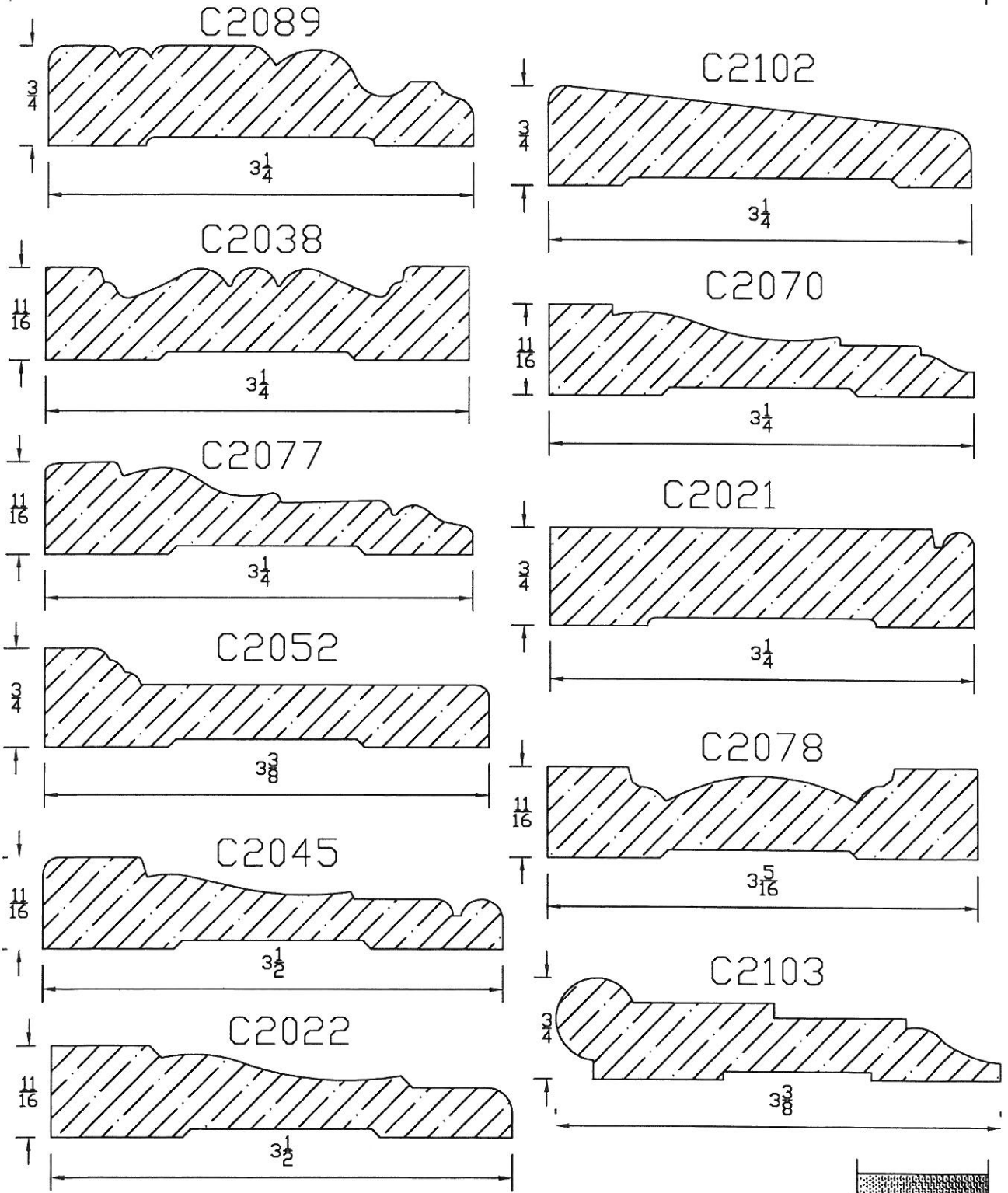

(Most Case can be modified for thickness some for width)



BALSAM MILLWORK CASING

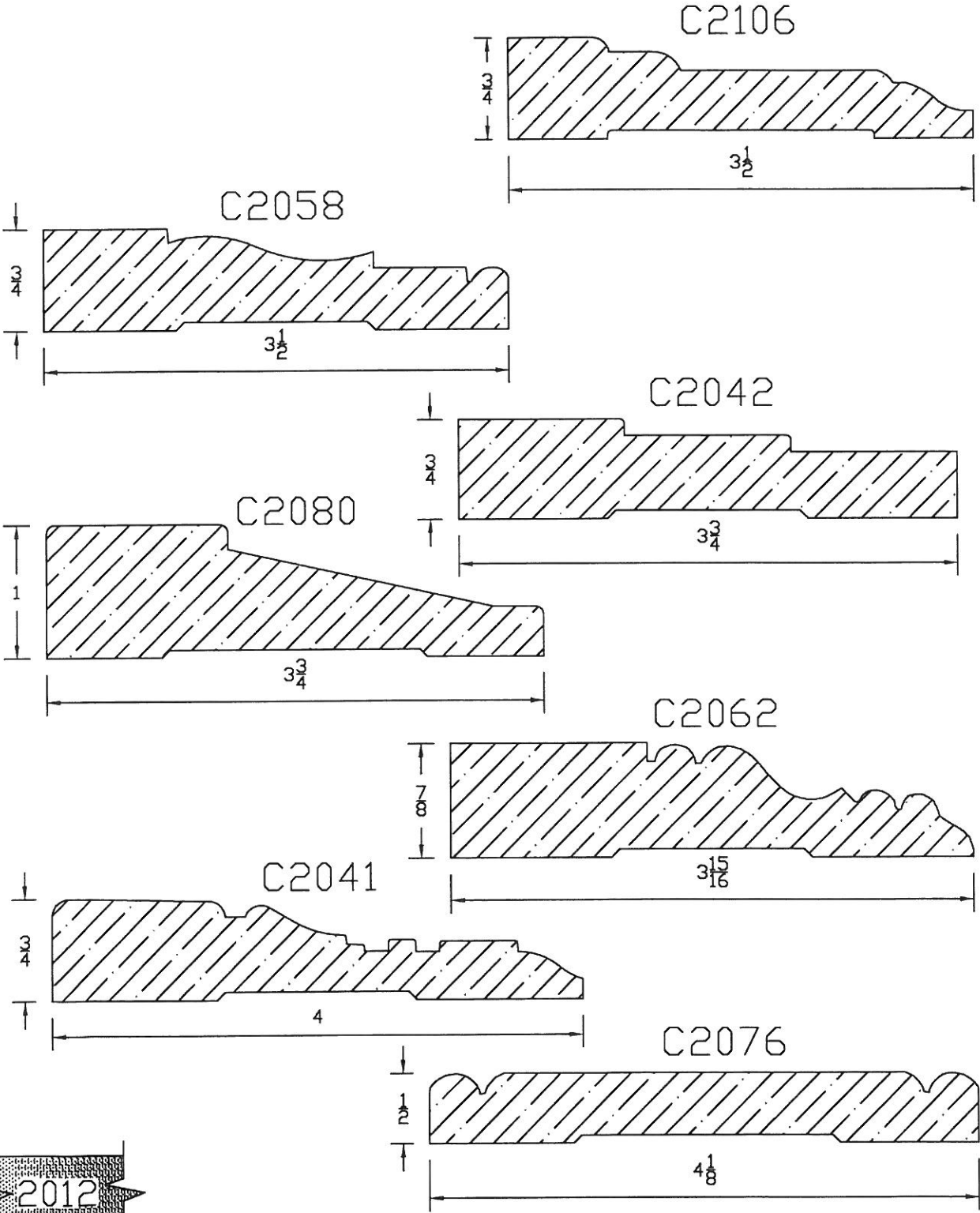

(Most Case can be modified for thickness some for width)

BALSAM MILLWORK CASING

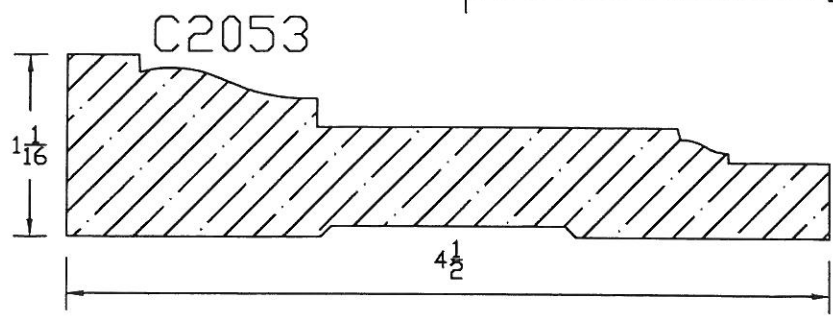
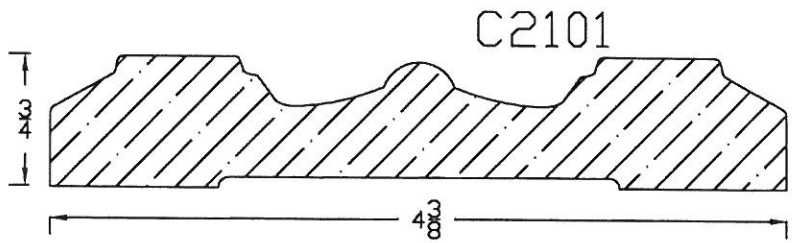
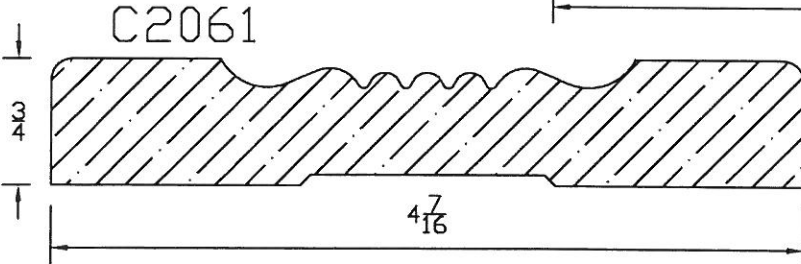
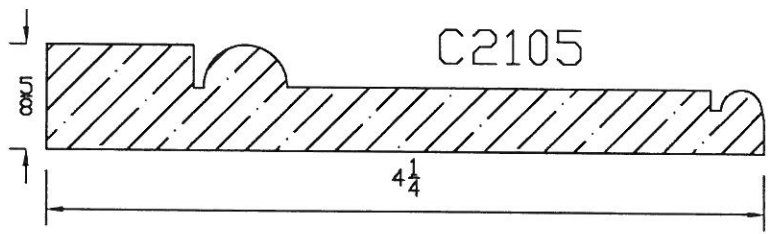
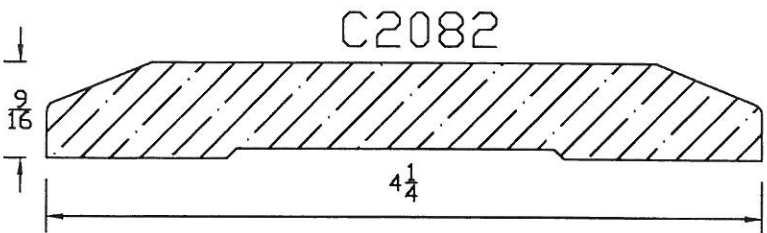
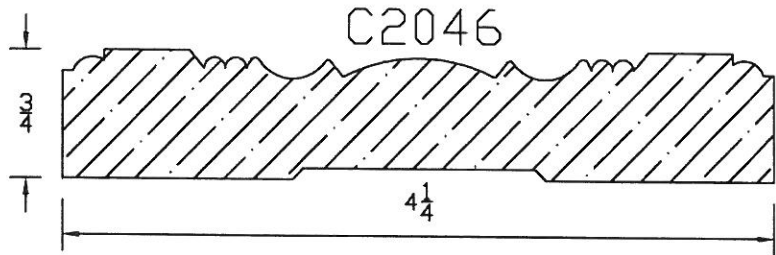

(Most Case can be modified for thickness some for width)

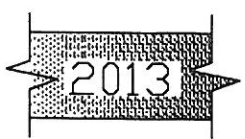

BALSAM MILLWORK CASING

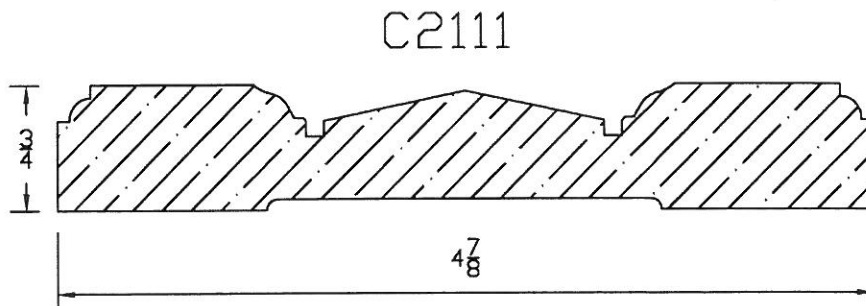
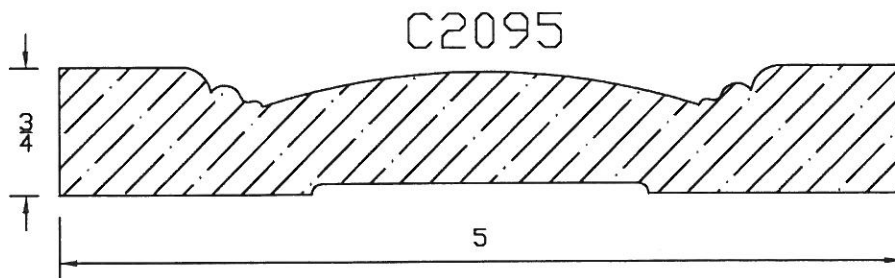
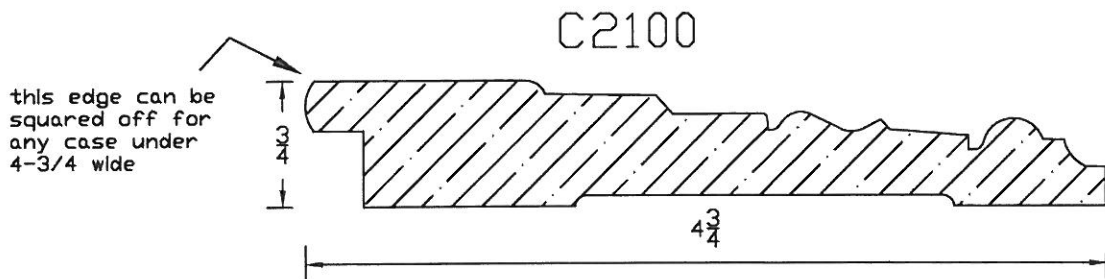
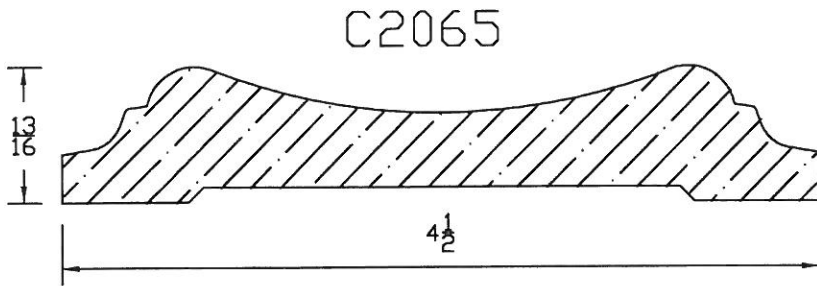
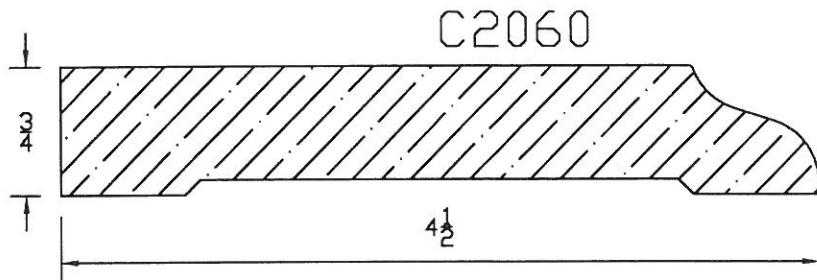

(Most Case can be modified for thickness some for width)

BALSAM MILLWORK CASING

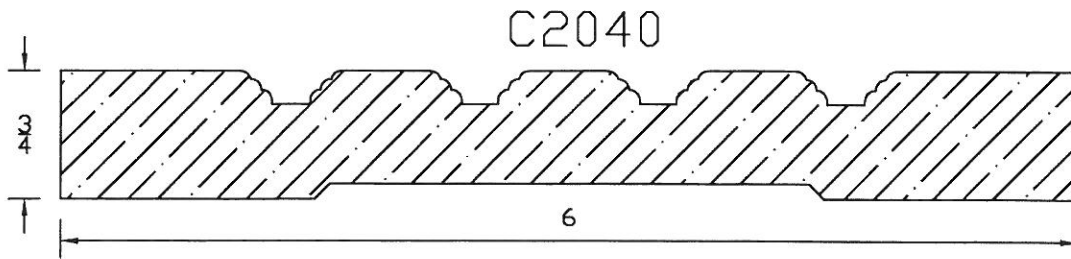
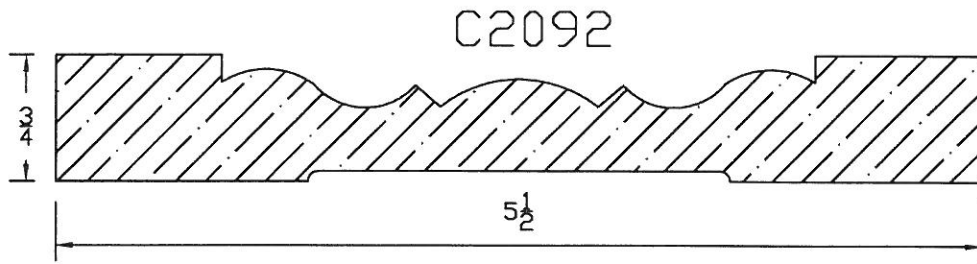
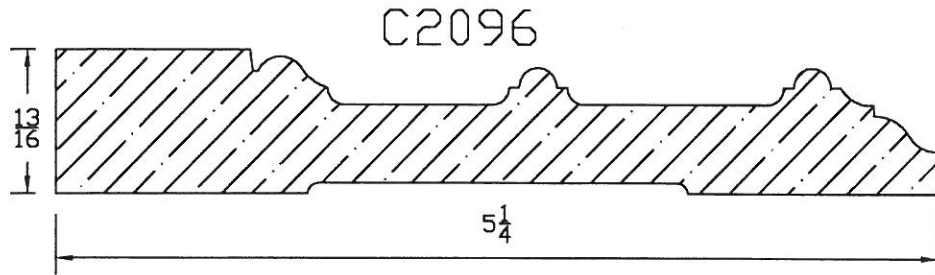

(Most Case can be modified for thickness some for width)



BALSAM MILLWORK FLUTED CASING

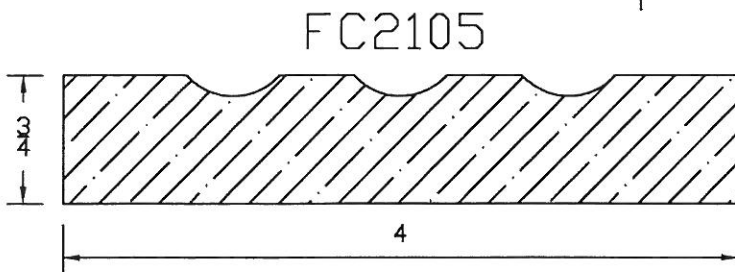
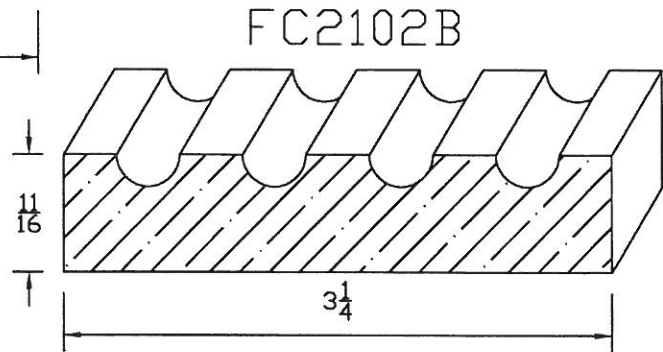
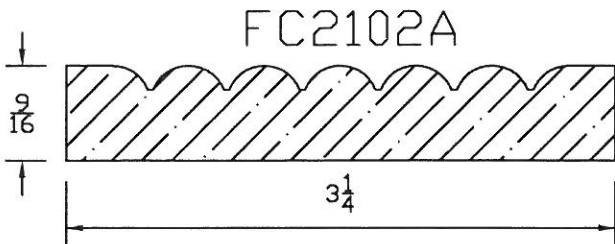
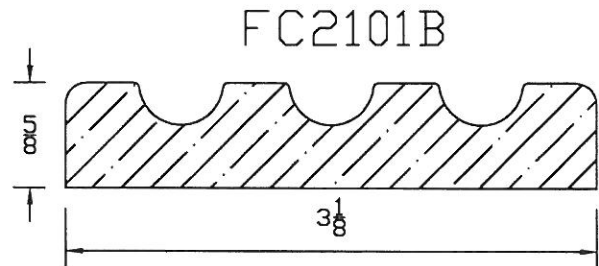
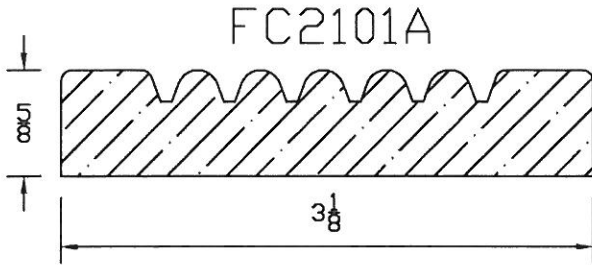
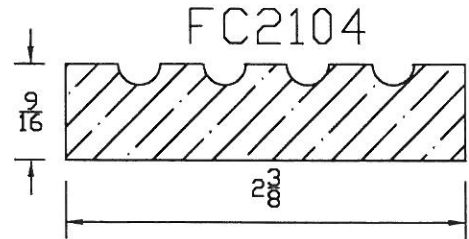
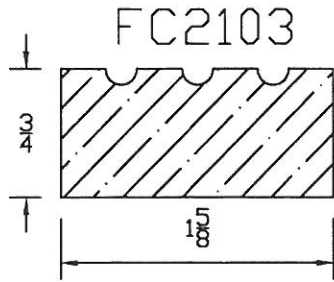

(Most Case can be modified for thickness some for width)



BALSAM MILLWORK MULLIONS

MULLIONS

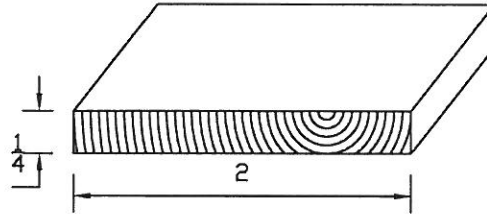

M11.00	=	$\frac{1}{4}$ "	\times	1"
M11.25	=	$\frac{1}{4}$ "	\times	1 $\frac{1}{4}$ "
M11.50	=	$\frac{1}{4}$ "	\times	1 $\frac{1}{2}$ "
M11.75	=	$\frac{1}{4}$ "	\times	1 $\frac{3}{4}$ "
M12.00	=	$\frac{1}{4}$ "	\times	2" (ILLUS.)
M13.00	=	$\frac{1}{4}$ "	\times	3"
M14.00	=	$\frac{1}{4}$ "	\times	4"
M15.00	=	$\frac{1}{4}$ "	\times	5"

ANY SIZE MULLIONS
AVAILABLE REQUEST ANY
THICKNESS OR WIDTH NEEDED

2018

BALSAM MILLWORK BACK BANDS

BB2208

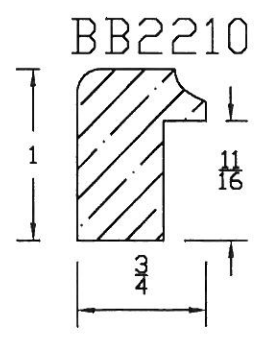
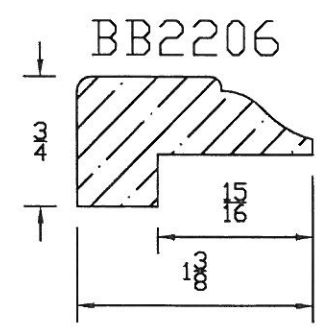
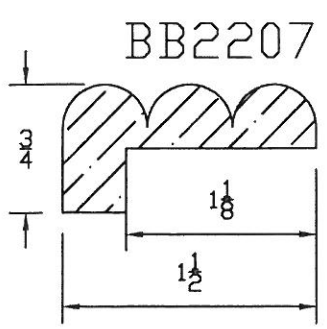
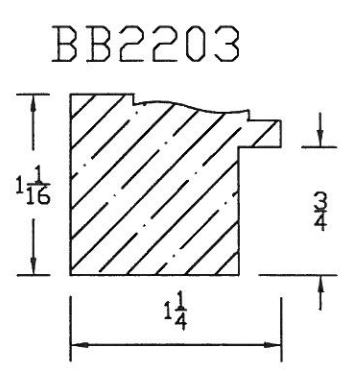
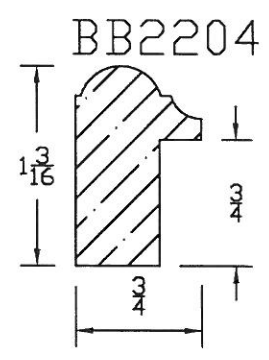
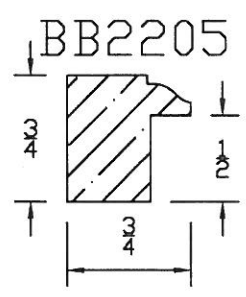
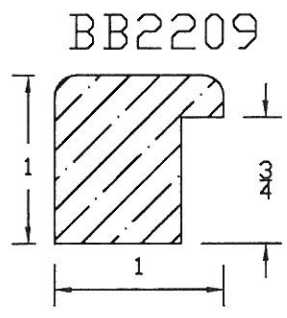
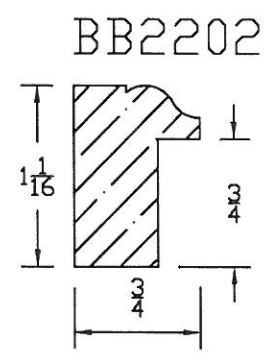
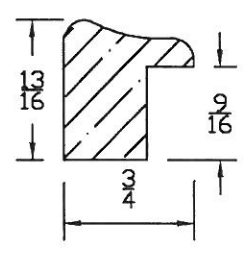
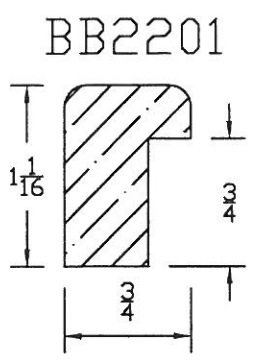

Most Back Bands
can be modified
to fit case